

RADIO

MARCH, 1945

Design • Production • Operation

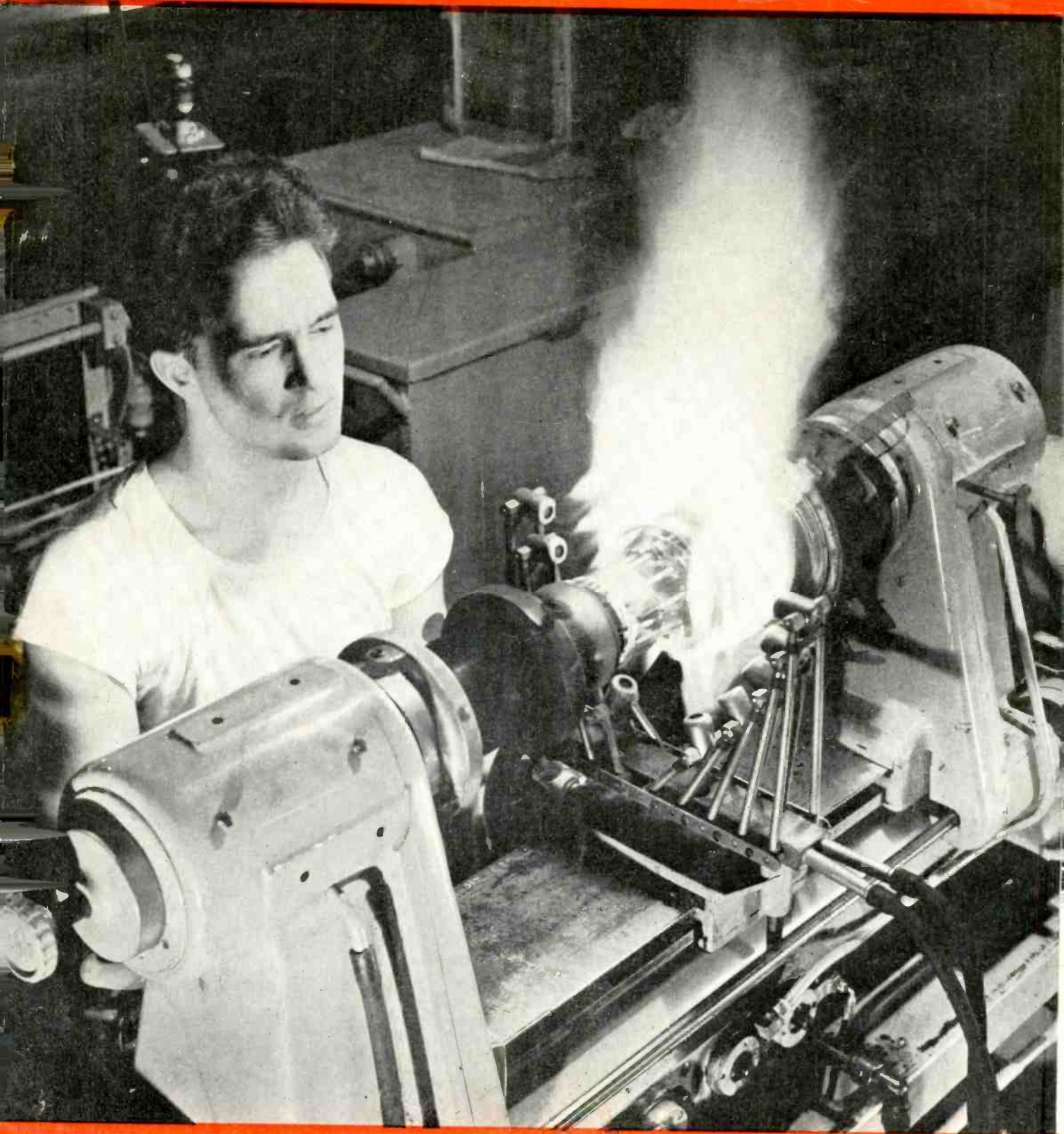

The Journal for Radio & Electronic Engineers

CLEVELAND YELLOW CAB COMPANY
Uses RAYTHEON TUBES
in world's first taxicabs with two-way radio!

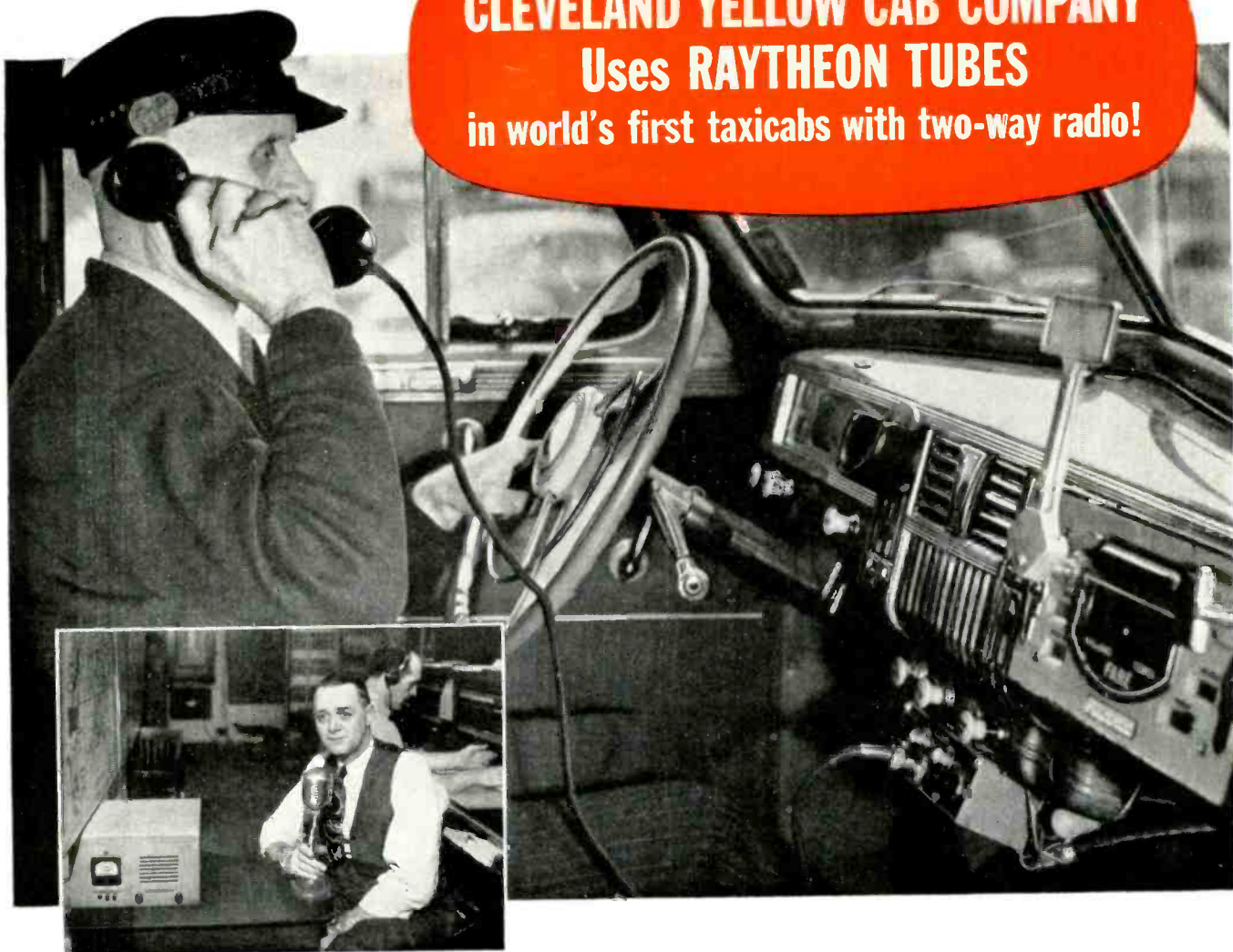

The eyes of the nation's transportation industry are on Cleveland these days, for it is there that the world's first taxicabs equipped with two-way radio are being demonstrated by the Cleveland Yellow Cab Company.

Officials say that dispatching has proved so much more efficient that future fleets similarly equipped will eliminate millions of miles of wasteful "dead" cruising. And they also report that Raytheon High-Fidelity Tubes, used in both transmitter and receivers, provide clear, dependable reception—even in the tunnels under Cleveland's Terminal Tower.

This application of Raytheon Tubes is just one of many being planned for the postwar period by progressive manufacturers in the electronics field.

If you are a radio service dealer, you, too, should realize that Raytheon's combined pre-war and wartime tube experience will result in even *better* tubes for all uses. Keep an eye on Raytheon . . . and watch for a Raytheon merchandising program that will help you be more successful, in the peacetime years ahead, than you've ever been before!

Increased turnover and profits . . . easier stock control . . . better tubes at lower inventory cost . . . these are benefits which you may enjoy as a result of the Raytheon standardized tube type program, which is part of our continued planning for the future.

Raytheon
Manufacturing Company
 RADIO RECEIVING TUBE DIVISION
 Newton, Massachusetts — Los Angeles
 New York — Chicago — Atlanta



RAYTHEON
High Fidelity
ELECTRONIC AND RADIO TUBES

DEVOTED TO RESEARCH AND THE MANUFACTURE OF TUBES FOR THE NEW ERA OF ELECTRONICS

When insulator design calls for *Quick Action*

DEPEND ON

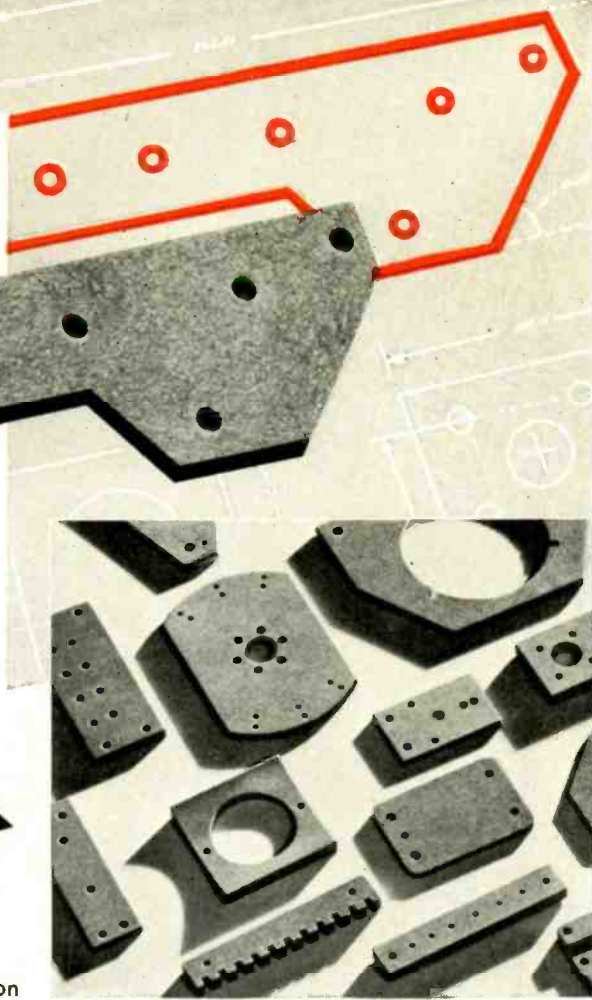

When time is of the utmost importance the ease and precision with which Mykroy can be fabricated into insulator parts makes it exceptionally useful to electronic and electrical engineers. Make those design changes on the spot . . . make them *quickly* and *economically* with Mykroy, for, here is a ceramic which can be worked in your own shop. Just transfer your design to the Mykroy sheet . . . then using conventional shop tools . . . produce the desired part by simple cutting, grinding, drilling, tapping and polishing techniques.

Because it has high structural strength and physical stability Mykroy can be machined to critical tolerances more readily than other types of ceramics. In addition, its electrical characteristics are of the highest order and do not shift under any conditions short of actual destruction of the insulation itself. This, plus excellent chemical and physical properties, makes it one of the best insulating materials ever developed for general and high frequency applications.

Get the full facts about this versatile dielectric now. Ask for a copy of the new MYKROY BULLETIN 102 which describes the new larger (19 1/4" x 29 3/4") sheet now available and call upon our engineers to help with your problems.

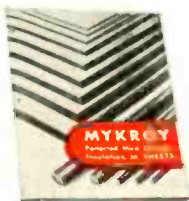

A representative group of parts fabricated in Mykroy to customer's specifications in our own plant. We have complete facilities to produce such parts in any quantities on rapid delivery schedules. Send us your specifications.

MECHANICAL PROPERTIES*

MODULUS OF RUPTURE.....18000-21000psi
 HARDNESS
 Mohs Scale 3-4 BHN. BHN 500 K9 Load. 63-74
 IMPACT STRENGTH.....ASTM Charpy .34-.41 ft. lbs.
 COMPRESSION STRENGTH.....42000 psi
 SPECIFIC GRAVITY.....2.75-3.8
 THERMAL EXPANSION......000006 per Degree Fahr.
 APPEARANCE.....Brownish Grey to Light Tan

ELECTRICAL PROPERTIES*

DIELECTRIC CONSTANT.....6.5-7
 DIELECTRIC STRENGTH (1/8").....630 Volts per Mil
 POWER FACTOR......001-.002 (Meets AWS L-4)

*THESE VALUES COVER THE VARIOUS GRADES OF MYKROY

- GRADE 8. Best for low loss requirements.
- GRADE 38. Best for low loss combined with high mechanical strength.
- GRADE 51. Best for molding applications.

Special formulas compounded for special requirements.

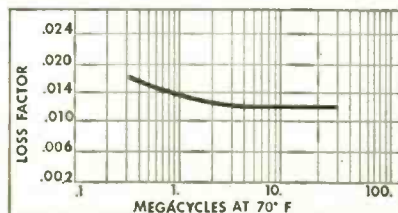

Based on Power Factor Measurements made by Bonton Radio Corp. on standard Mykroy stock.

MADE EXCLUSIVELY BY

ELECTRONIC MECHANICS INC.

70 CLIFTON BLVD., CLIFTON, N. J.
 CHICAGO 47; 1917 N. Springfield Ave., Tel. Albany 4310
 EXPORT OFFICE: 89 Broad Street, New York 4, New York

MYKROY IS SUPPLIED IN SHEETS AND RODS - MACHINED OR MOLDED TO SPECIFICATIONS

Do you really get the BEST in Vibration Control ?

Here is proof of the performance of the new Robinson Vibrashock* suspension, using the exclusive double neutral axis principle as compared with a conventional type shock mount formerly used for the same equipment.

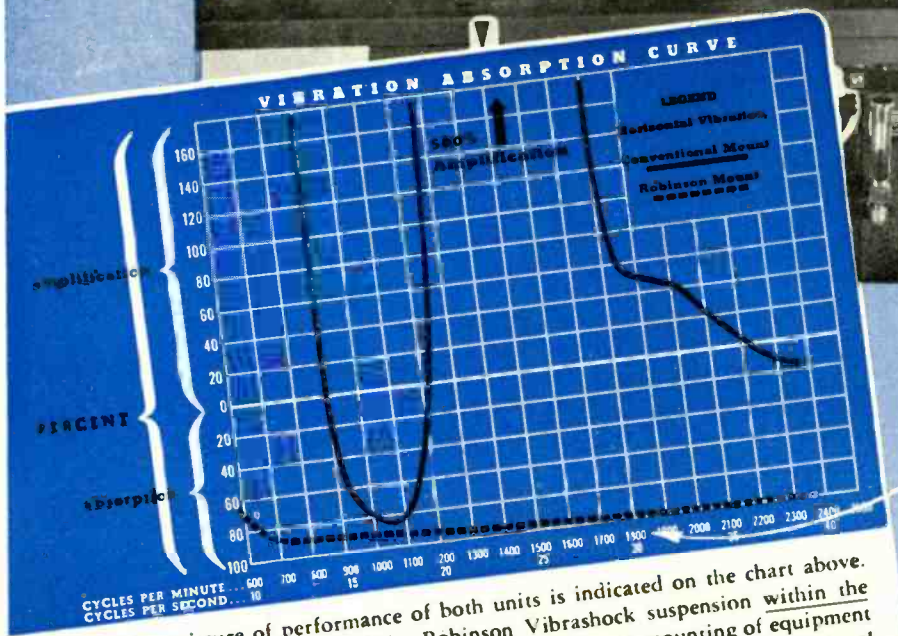
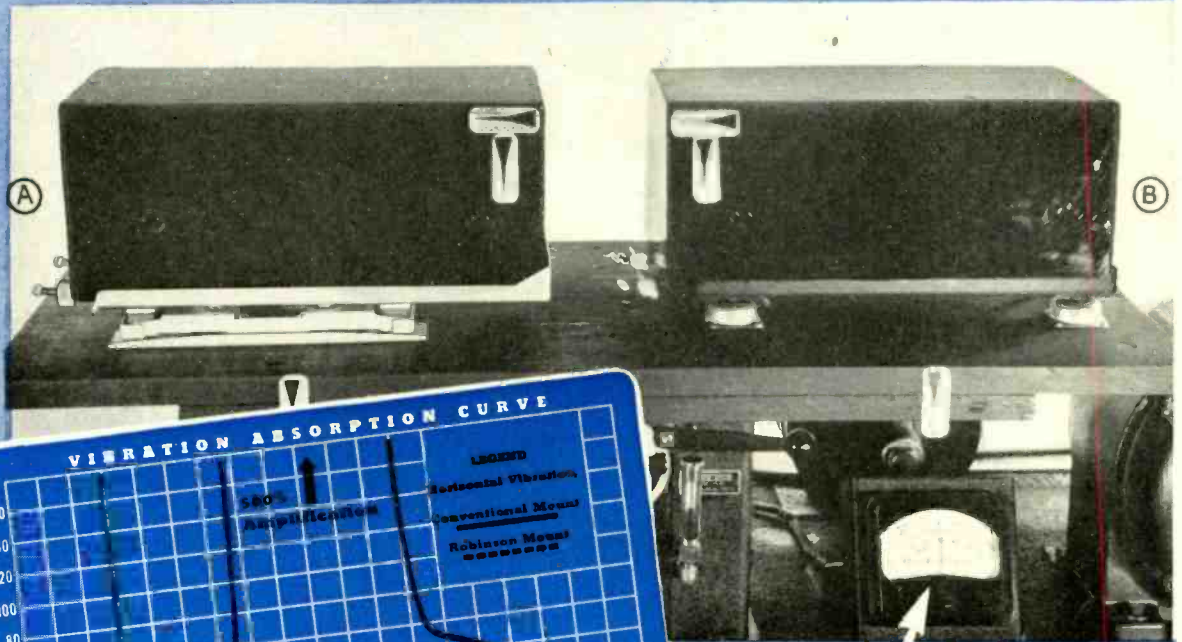

The complete picture of performance of both units is indicated on the chart above. Note the smooth performance of the Robinson Vibrashock suspension within the entire operating ranges of aircraft. It is apparent that the mere mounting of equipment "in rubber" does not insure protection from vibration and shock. In fact, conventional type mounts often amplify vibration 300% or more.

Two identical mock-ups of an electronic unit — supported by (A) Robinson Vibrashock suspension and (B) conventional shear type mount — are both mounted on the same shake table set for a horizontal amplitude of 1/32 of an inch. The vibration frequency — 1800 cycles per minute — is found within the normal cruising speed range of most airplanes.

Robinson engineers build the only complete, fully engineered suspension guaranteed to absorb over 90% of all vibration throughout the entire aircraft operating range. This is an efficiency rating far beyond accepted standards, and it makes possible performance and reliability previously unobtainable for electronic equipment. Our services are available to aircraft, radio, and electronic manufacturers and users. * Trade Mark

ROBINSON AVIATION, INC.

750 FIFTH AVENUE, NEW YORK 19, N. Y.

FIRST NATIONAL BUILDING, HOLLYWOOD 28, CALIF.

RADIO

Published by RADIO MAGAZINES, INC.

John H. Potts Editor

Sanford R. Cowan Publisher

MARCH 1945

Vol. 29, No. 3

CONTENTS

COVER

Sealing the .125" diameter tungsten leads after insertion in glass blank— one of the operations in assembling the filament stem of a 50-kilowatt broadcast and industrial tube at the Clifton, New Jersey plant of Federal Telephone and Radio Corporation.

ARTICLES

- Notes on Inductance Calculation—*William Vissers, Jr.* 31
A simplified method of designing a coil to give a desired value of inductance
- Broadcast Transmitter Installation and Tuning—*Harold E. Ennes* 32
Practical data on setting up a high-power transmitter and getting it into operation
- Measurement of Receiver Characteristics, Part 3—*A. C. Matthews* 35
Information on approved receiver test methods
- Difficulties in Multiphase Filament Operation—*H. W. Baker & A. K. Wing, Jr.* 40
An analysis of troubles encountered in operating filaments of transmitting tubes and how difficulties may be minimized
- Communication and Control Relays—*Geoffrey Herbert* 44
A survey of relays with practical data regarding their characteristics and applications
- Measuring Resistance of Hot Filaments—*A. K. McLaren* 49
Describing a resistance bridge to test elements whose resistance changes with heat
- Parallel Resistance Chart—*C. J. Merchani* 50
This chart differs from others in that the error in the resultant resistance shown is constant and within 1% of the indicated value
- Radio Design Worksheet: No. 34—A-F Transformers in Multiple and Series; Polyphase Circuits 51
- Chart—Amplitude vs. Phase Angle for Series Tuned Circuit 56
- Radio Bibliography: 17—Aircraft Radio, Part 7—*F. X. Rettenmeyer* 63

MISCELLANEOUS

- Transients 5
- TECHNICANA
- Wave Traps 11
- Signal Generator 14
- Noise in Amplifiers 14
- Book Review 18
- This Month 53
- New Products 57
- Advertising Index 82

John H. Potts President

Sanford R. Cowan Sec'y-Treas.

Charles H. Farrell Adv. Manager

Ann Limberg Adv. Production

Miriam Birnbaum Circl. Manager

PACIFIC COAST REPRESENTATIVE

Lloyd B. Chappell,
427 West 5th St., Los Angeles, Cal.

OHIO-PENNA. REPRESENTATIVE

A. Hawley & H. Stuart
Bulkley Bldg., Cleveland, Ohio

GREAT BRITAIN REPRESENTATIVE

Radio Society of Great Britain,
New Ruskin House, Little Russell St.,
London, W.C. 1, England

RADIO Magazine (title registered U. S. Pat. Off.) is published monthly at 145 Madison Avenue, New York, N. Y. Subscription rates—United States and Possessions, \$3.00 for 1 year, \$6.00 for 2 years; elsewhere \$4.00 per year. Single copies 15c. Printed in U.S.A. All rights reserved, entire contents Copyright 1945 by Radio Magazines, Inc. Entered as Second Class Matter October 21, 1942, at the Post Office at East Stroudsburg, Pa., under the Act of March 3, 1879. Permit for Second Class status pending at Orange, Connecticut.

For the "Newspaper of the Air"

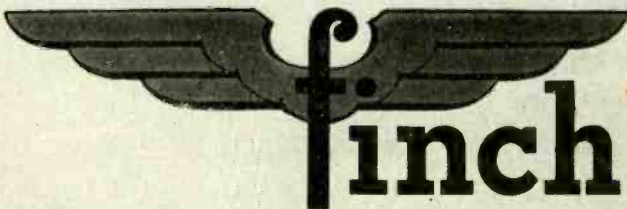

SELF SYNCHRONIZING

Finch facsimile

DELIVERS PICTURES AND TEXT BY RADIO OR WIRE

FINCH TELECOMMUNICATIONS, INC. • PASSAIC, N. J.

Transients

TELEVISION PLANNING

Some interesting facts regarding the present status of television were outlined by Lewis M. Clement, vice-president in charge of research and engineering, Crosley Corporation, at a recent meeting. Mr. Clement said:

"It is estimated that there are approximately 7200 receivers in the field," he said, "and the possible maximum viewing audience is of the order of 40,000 to 50,000 people. The stations and receivers are distributed as follows:

New York	3 stations	5000 receivers
Philadelphia	1 station	1200 receivers
Schenectady	1 station	450 receivers
Chicago	2 stations	300 receivers
Los Angeles	2 stations	250 receivers

These stations operate in the 50-78 mc bands and provide 525 line picture in accordance with pre-war standards. A television band requires 6 megacycles band width as contrasted with .2 megacycles for frequency modulation and .01 megacycles for sound broadcasting.

"The television receivers in use at the present time are at least four or more years old and in most cases are operating with old and used tubes. Their present performance is poorer than their original performance. With present knowledge, it is possible to make better transmitting and receiving equipment which will provide brighter and larger pictures having more contrast.

"These receivers will produce useful pictures in normally lighted living rooms. It will not, therefore, be necessary to sit in a dark room to enjoy a television program. Receivers for home use have been built which project the image on the screen and produce a picture 18" x 24". The brilliance is sufficient so that it is not necessary to turn off the floor lamps in a normal living room. It is generally believed that a 7" x 9" picture is the minimum size that will be satisfactory in the home, even in a table type set.

"For a projection type of receiver of which the brilliant image on the end of a 5" tube is projected on a screen by means of a reflective optical system, a 15" x 20" or 18" x 24" picture is believed to be as large as will be required.

"Experience has shown that the proper viewing distance of a television or motion picture image is between 4 and 8 times the height of a picture. Thus, for a 7" picture, the viewing distance should be 2½ to 5 feet; for an 18" picture, 6 to 12 feet, and for a normal motion picture screen of 15 feet in height, 60 to 120 feet.

"The 7" picture produced by a table type television set is therefore satisfactory for a small family group. An 18" picture is about as large as is required for an ordinary living room.

"It is likely that television receivers of the table type eventually will be available for \$200 or less and of the

console type with projection picture, for approximately \$350 or more."

For those who are inclined to be over-enthusiastic about the prospects of television, it is well to contrast Mr. Clement's estimate of 7200 television receivers now in use after a decade of publicity with a recent estimate of over 59,000,000 radio broadcast receivers now owned by over 30,000,000 families. Television has a long and hard road to travel before it will even approach the public acceptance achieved by broadcast receivers two decades ago.

DESIGN CHANGES

It is probably true that no radio product is wholly satisfactory to its designer. There are so many methods of accomplishing the same result, so little time for experimentation, so many ideas which arrive just a little too late, that the brain-child which steps off the production line usually falls far short of its designer's expectations.

In many companies, this situation is realized and a product improvement group sets to work to make design changes intended either to reduce costs or to improve performance, or both. But when the purpose is mainly to reduce costs, the design change which looked so good in the laboratory often has precisely the opposite effect. To the laboratory engineer, a circuit change which reduces the cost of components by, say, 5%, without affecting performance, looks like a good idea. To the production engineer who has developed jigs, made time studies, trained operators, installed wage incentive plans around the original design, a saving of this amount in component cost may not be considered worth while.

Just why this is so may be understood by considering some of the results secured by production engineering. The WPB has reported an average increase in production of 40% in a large number of war plants, simply by substituting wage incentive plans for hourly wages. These plans are usually worked out on a fifty-fifty basis, so the worker gets one-half the saving, and the labor cost is thus reduced 20%. By careful analysis of operations it is frequently possible to increase productivity as much as 30%. By contracting for large quantities of components well in advance of production, further savings are effected. Because cancellations are expensive and workers who have developed speed in performing operations one way do not relish re-learning their jobs at reduced pay, the net result of some design changes is increased costs and lower production.

In post-war production, those companies who rush in to feed a famished market with half-baked designs, and who rely upon design changes to get the "bugs" out and the profits in, are likely to be disappointed. Better get it right the first time!

J. H. P.

IN ELECTRONICS "Quality" HAS A SPECIAL MEANING

AMPHENOL confirms

Quality

BY AFFIDAVIT*

AMPHENOL
AMERICAN PHENOLIC CORPORATION
ULTRA HIGH FREQUENCY CABLE TEST REPORT

In Accordance With U.S. Navy (U.S. Navy) Army (U.S. Army) General Specifications No. 1001

Serial Specification No. _____ Date _____

Part No. _____ Name _____

Production No. _____

Amphenol No. _____ Signals _____

CHARACTERISTIC IMPEDANCE _____ Ohms

VELOCITY PROPAGATION _____ % of C

CAPACITANCE _____ pF/100 ft.

RESISTANCE _____ Ohms/100 ft.

LOSS TEST _____ dB/100 ft.

TEMPERATURE TEST _____

COLD BEND TEST _____

DEFORMATION _____

U.S. Government Inspection _____

SEAL _____

AFFIDAVIT
 I, _____ of _____ do hereby certify that the above information and test results on this cable conform to the test results on file in the laboratory of _____ and are true and correct to the best of my knowledge and belief.

AMERICAN PHENOLIC CORPORATION
 Chicago 50, Illinois
 In Canada, Amphenol Limited, Toronto



*At Amphenol all U.H.F. Cable is thoroughly inspected and must bear affidavit of test approval before shipment.

Extra significance is attached to the whole idea of *Quality* when it applies to electronic equipment. High-frequency currents make special demands of a technical nature that go far beyond the standards of good material and high quality workmanship.

Such requirements are a familiar story to Amphenol, one of the pioneers and leaders in the low-loss transmission equipment field. Amphenol makes the most complete line of both solid dielectric flexible U.H.F. Cables and U.H.F. Connectors and they are now being produced in tremendous volume.

Actually Amphenol's own tests and inspections go beyond required performance and tolerances. Amphenol tests for *outstanding quality* assure dependable performance under the most difficult of conditions.

Depend upon

AMPHENOL

Quality

AMERICAN PHENOLIC CORPORATION
 Chicago 50, Illinois
 In Canada, Amphenol Limited, Toronto

U.H.F. Cables and Connectors
 Conduit
 Fittings
 Connectors
 (A-N, U.H.F., British)
 Cable Assemblies
 Radio Parts
 Plastics for Industry



Amphenol U.H.F. Coax Cables with Amphenol Low-Loss Connectors.

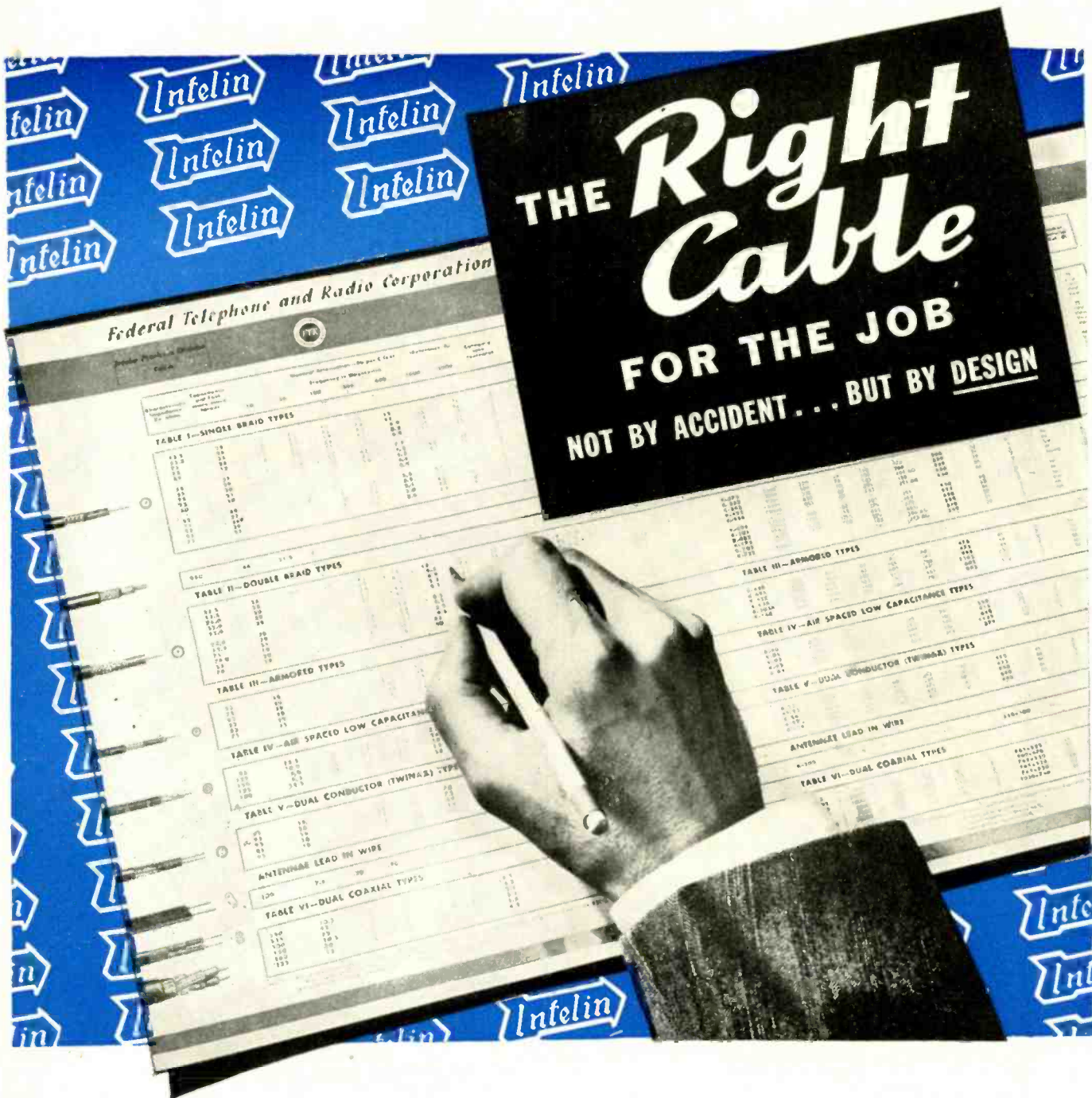

To assist the equipment designer Federal offers comprehensive data on high frequency cables.

This technical information sheet provides the design-engineer with pertinent electrical and physical characteristics...including impedance, capacitance, attenuation, diameter, materials, and weight... for Federal's wide variety of high-frequency cables.

Single and double braid, armored, dual con-

ductor and dual coaxial, air-spaced, low capacitance lines, and antenna lead-in wire... there's a right type for your job, backed by the built-in superiority that's a tradition with Federal.

Special developments in flexible low-loss cables by Federal have resulted in superior cables for all types of transmission. For a better job, see Federal first.

Write for your cable information sheet today.



Federal Telephone and Radio Corporation

Newark 1, N. J.



SYLVANIA NEWS

ELECTRONIC EQUIPMENT EDITION

MARCH

Published in the Interests of Better Sight and Sound

1945

Well-Equipped Sylvania Plant Makes Own Small Parts to Assure Top Quality in Radio Tubes

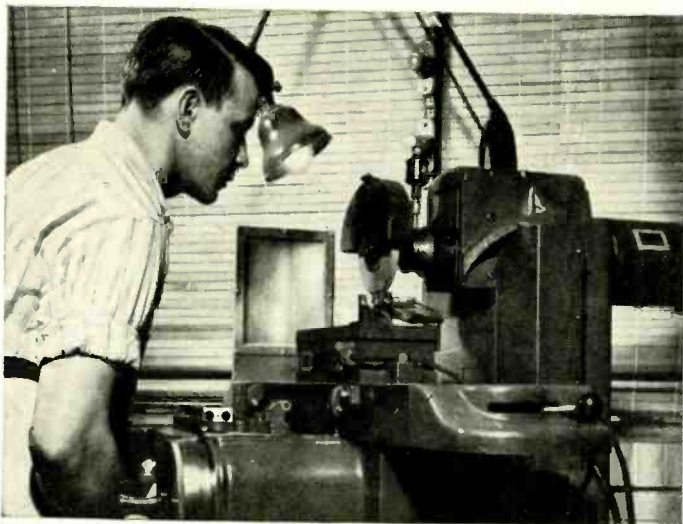

Many of the special tools required for turning out small tube parts are tailor-made right at Sylvania's Emporium plant.

To insure that all Sylvania-made radio tubes will be of the very best quality, the well equipped tube plant in Emporium, Pennsylvania, provides extensive facilities for making over 8500 of the delicate small parts that go into Sylvania tubes.

Each month over 600 million small parts are turned out. In making these intricate parts, Sylvania craftsmen work with a variety of metals such as tungsten, steel, copper, phosphor bronze, beryllium copper and tantalum.

The Emporium staff includes highly skilled production engineers, tool and design men, and expert tube makers.



By a sampling method, watchful Sylvania inspectors carefully study each batch of small parts for detailed perfection.



Tiny tube parts are magnified and their outlines superimposed on scale drawings to insure meeting the extremely close dimensional tolerances required.

SYLVANIA ELECTRIC

SYLVANIA ELECTRIC PRODUCTS INC., Emporium, Pa.

MAKERS OF RADIO TUBES; CATHODE RAY TUBES; ELECTRONIC DEVICES; FLUORESCENT LAMPS, FIXTURES, ACCESSORIES; INCANDESCENT LAMPS



ALLEN H. GARDNER, Pres.
Colonial Radio Corporation



BERNARD WAHLE, Pres.
National Trailways Bus System

Leaders all- These Men in Industry . . . E-L in Current Conversion

These, and many other industrial leaders, anticipate improvements in their postwar equipment which will require current conversion. Vibrator Power Supplies lead the field in current conversion because of their efficiency, versatility, ease of maintenance, and flexibility in size and weight.

Specializing in design and production, Electronic Laboratories, the world's largest manufacturer of Vibrator Power Supplies, has pioneered and perfected many exclusive developments such as multiple input and output, constant output voltage systems, and heavy duty units with capacities up to 1000 watts.

Wherever current must be changed in voltage, frequency or type—especially DC to AC, for which there is an ever increasing demand—consider an E-L Vibrator Power Supply first. Consult with E-L engineers on *your* current conversion needs.



W. J. MALLIGAN, Pres.
Mallcrafters Radio



COLONEL JOHN CASEY, Mgr.
Chicago Municipal Airport



W. A. PATTERSON, Pres.
United Air Lines



JOHN E. MCCARTHY, Pres.
Fifth Avenue Coach Company



J. F. MacENULTY, Pres.
Pressed Steel Car Company, Inc.



Electronic

LABORATORIES INC.

INDIANAPOLIS

VIBRATOR POWER SUPPLIES FOR LIGHTING, COMMUNICATIONS AND ELECTRIC MOTOR OPERATION • ELECTRIC, ELECTRONIC AND OTHER EQUIPMENT

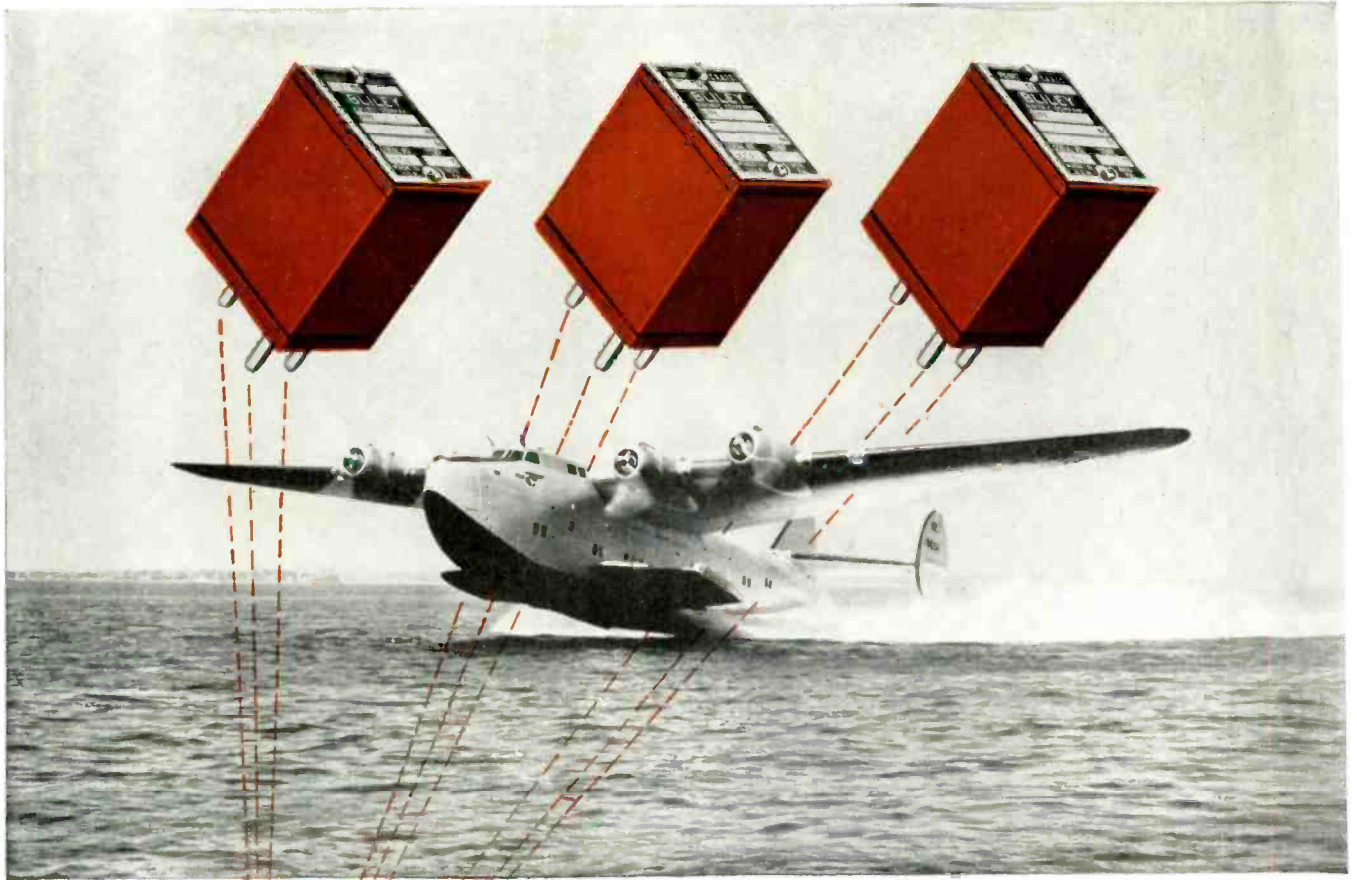

BLILEY CRYSTALS, of course, fly with Pan American

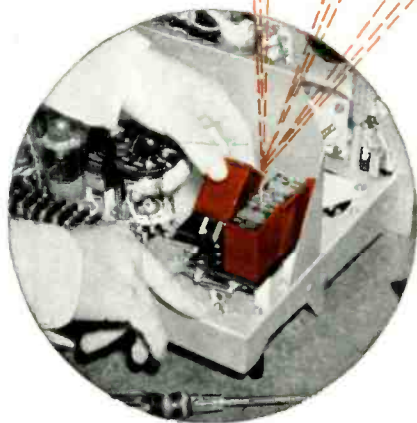

Bliley *acid etched** crystals persistently show up wherever there is an important communications job to be done such as the combination two-way telephone and telegraph and range finder systems of Pan American World Airways. In peace and in war Bliley crystals have flown millions of world-wide miles with their famous Clippers.

Bliley crystals are pre-conditioned for just such rugged assignments. In the Bliley Electric Company plant there is a large section where Bliley

*acid etched** crystals receive their pedigree. Here each crystal gets "the works". Its activity and frequency are *proved* under tough laboratory created service conditions of altitude, humidity, temperature, immersion, shock and vibration.

But licking tough assignments is a tradition with Bliley engineers and craftsmen. This background of research and skill has been responsible for the distinguished record of Bliley Crystals in every field of radio communication. Whatever your crystal problem may be—specify Bliley.

+ + +

*Acid etching quartz crystals to frequency is a patented Bliley process.
United States Patent No. 2,364,501

Do more than before . . .
buy extra War Bonds

★ A new star has been added



Bliley CRYSTALS

BLILEY ELECTRIC COMPANY • UNION STATION BUILDING • ERIE • PENNSYLVANIA

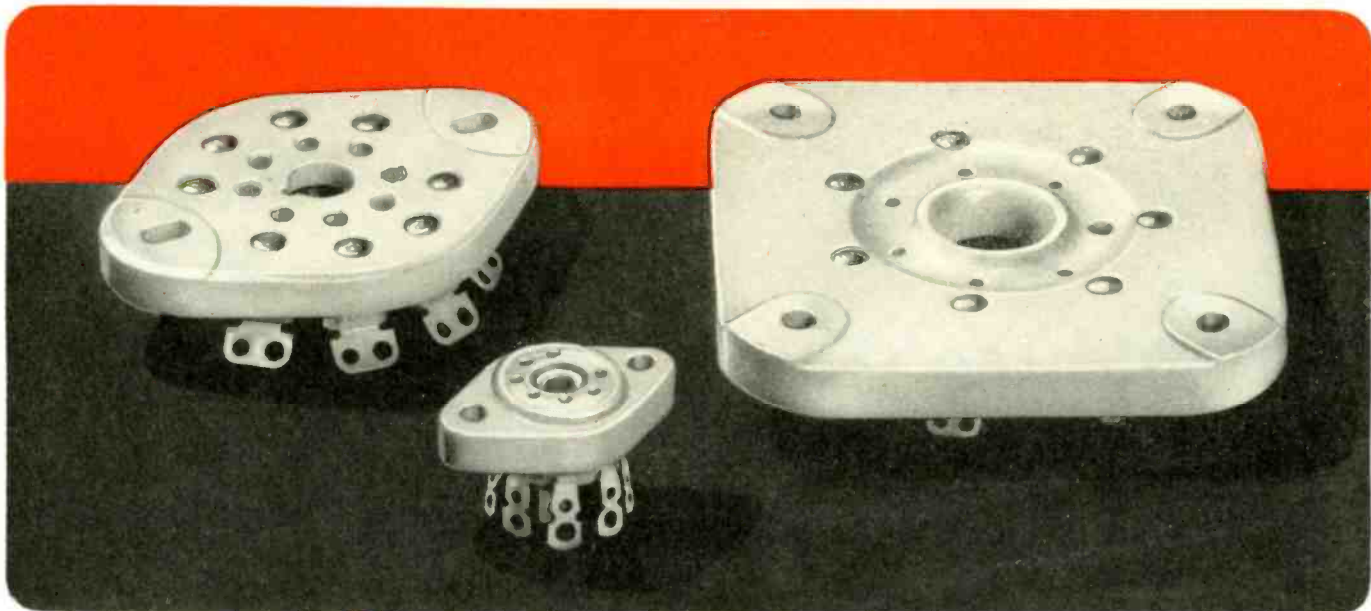

WHO *first* MADE IT?

Pardon us, if we presume to insert the "first," but in casting about for suppliers you've asked that question, perhaps hundreds of times.

Users of ceramic sockets will recognize the types illustrated. The No. 267 was the first ceramic miniature socket — still widely used, and formed the basic design for the later types with cylindrical metal shield base. (Yes, Johnson makes them too, our No. 277B.)

The No. 228 octal is one of a series of oval ceramic wafer sockets originated 7 years ago. Engineering improvements then made over existing types (such as mounting bosses, countersunk rivet heads, "non-turning" contacts, etc.) established it a favorite for Signal Corps and Navy equipment.

Almost equally familiar is the basic square design of the No. 247, a series started 6 years ago, embodying essential features of the smaller Johnson sockets.

But to get back to the first question, "Who (first) made it?" when you're looking for original parts, tube sockets, or other components why not avail yourself of our kind of engineering and production experience?

Ask for catalog 968 (K)

*Specialists
in*

- CONDENSERS
- INSULATORS
- SOCKETS
- PLUGS
- INDUCTORS
- CHOKES
- COUPLINGS
- ANTENNA PHASING UNITS

JOHNSON



a famous name in Radio

E. F. JOHNSON COMPANY • WASECA • MINNESOTA

RADIO

★ MARCH, 1945

9

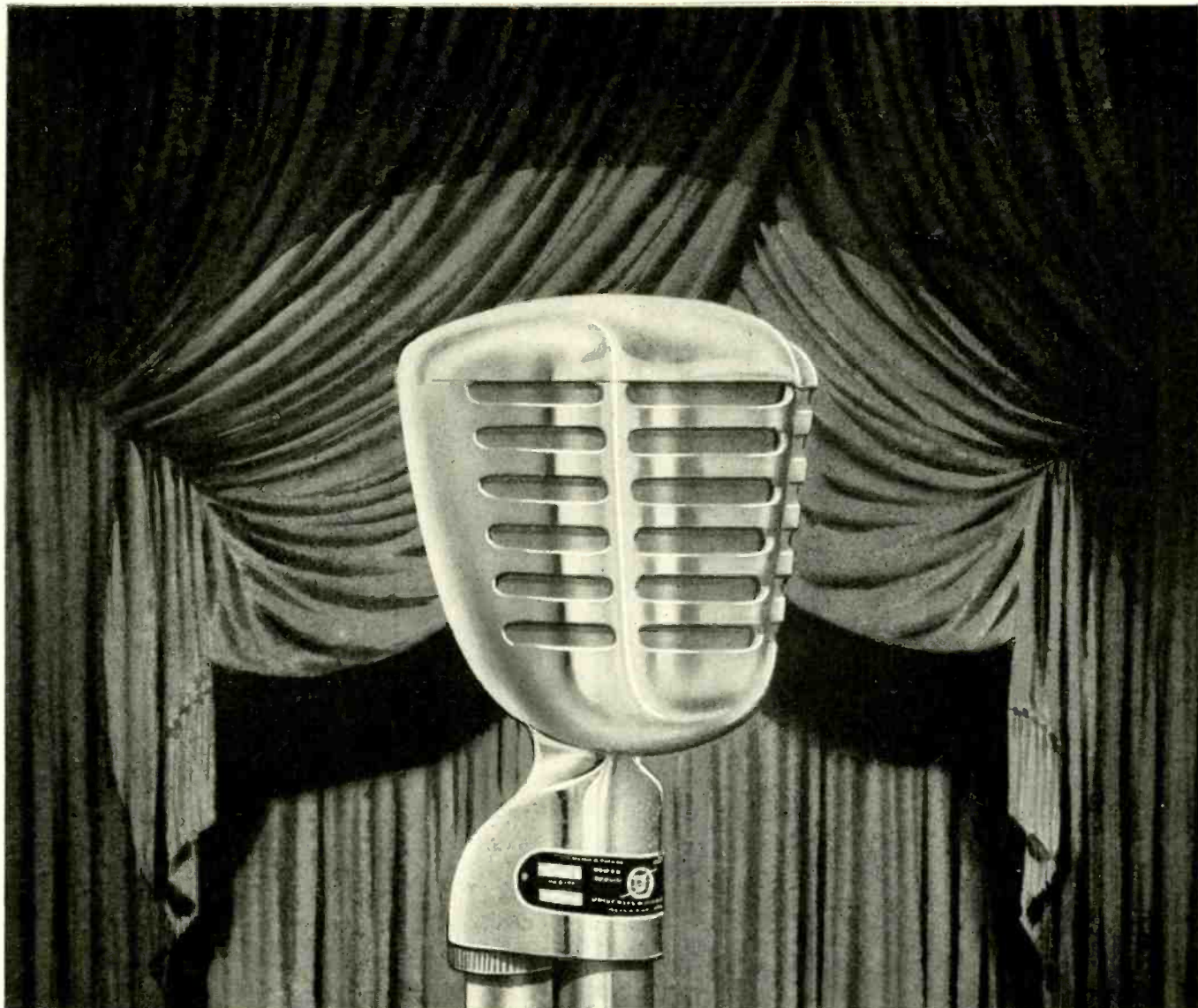

UNIVERSAL'S NEW D-20 MICROPHONE



The stage was set for something new and here it is. Universal's new D-20 Microphone . . . soon on your radio parts jobbers' shelves to fill your essential requirements . . . uses Universal's "Dynoid" construction . . . A dynamic microphone of conventional characteristics built to fill the utility requirements of war time plus advance styling of the many modern things to come. Orders placed now with your Radio Parts Jobbers will assure early delivery when priority regulations are relaxed.

◀ *FREE* — *History of Communications Picture Portfolio*. Contains over a dozen 11" x 14" pictures suitable for office, den or hobby room. Write factory for your Portfolio today.

UNIVERSAL MICROPHONE COMPANY
INGLEWOOD, CALIFORNIA



FOREIGN DIVISION: 301 CLAY STREET, SAN FRANCISCO 11, CALIFORNIA -- CANADIAN DIVISION: 560 KING STREET WEST, TORONTO 1, ONTARIO, CANADA

TECHNICANA

WAVE TRAPS

The use of a wavetrapp for tuning out undesired frequencies is commonly thought of as a thing of the past. Mr. S. W. Amos, writing in the February, 1945, issue of *Wireless World*, points out that in localities close to strong disturbances a wavetrapp may be required, even with a high quality modern receiver.

Either a series or shunt wavetrapp may be used, depending upon whether the unwanted frequency is higher or lower than the frequencies which we would like to boost, and also upon the input resistance of the receiver.

The series wavetrapp is illustrated in Fig. 1. The attenuation of the unwanted

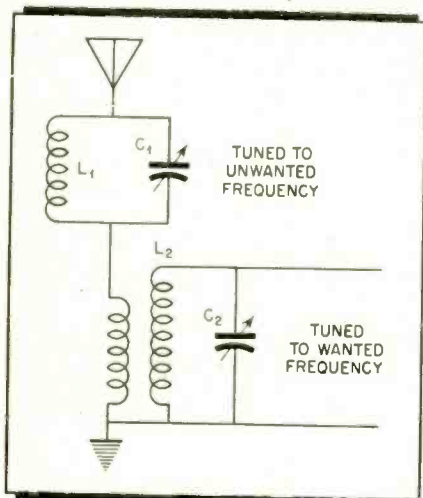

Figure 1

frequency is $R_2/R_1 + R_2$ in which R_2 is the receiver input resistance and R_1 is L_1/C_1R where R is the r-f resistance of L_1 .

If the wanted frequency is higher, the wavetrapp will be capacitive, introducing a higher attenuation for the

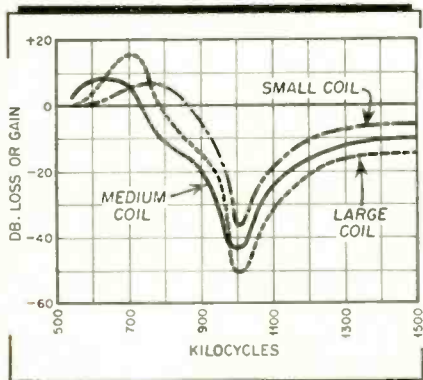

Figure 2

BETTER PERMANENT MAGNETS

for:

RADIO, SOUND and COMMUNICATIONS EQUIPMENT



AUTOMOTIVE and AVIATION EQUIPMENT



INSTRUMENTS



However advanced your own product-development work may be . . . however new or revolutionary the permanent magnets you require . . . Arnold engineers can be of considerable assistance to you in supplying the proper permanent magnets *in volume*. They're precision-built entirely in our own plant, under the closest metallurgical, mechanical and magnetic control to assure peak efficiency at the lowest cost.



NEW! Get your copy of this valuable, up-to-the-minute manual on the design, production and application of modern Alnico permanent magnets. Write us, on your company letter-head, today.

Specialists in the manufacture of
ALNICO PERMANENT MAGNETS

THE ARNOLD ENGINEERING COMPANY

147 EAST ONTARIO STREET, CHICAGO 11, ILLINOIS

ONE CENTRAL SOURCE FOR All Types of Industrial ELECTRONIC TUBES

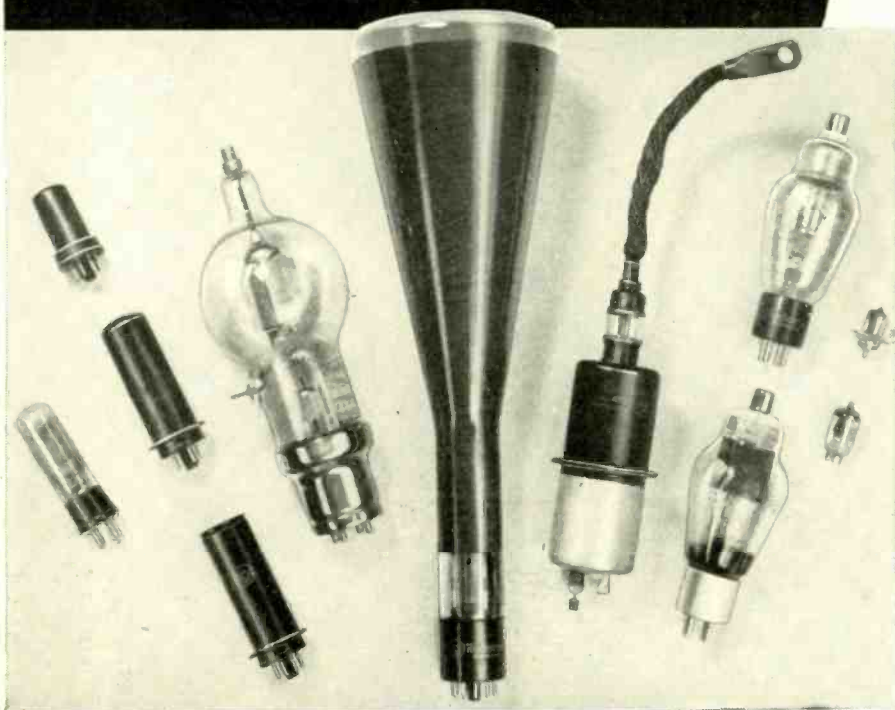

STOCKS ON HAND FOR
Immediate Delivery

RECTIFIER
POWER
CONTROL
PHOTO-ELECTRIC
TRANSMITTING
RECEIVING

Here you have the advantage of a complete, centralized service on all types of industrial electronic tubes. Many are "on-hand" for rush delivery! This enables you to obtain the exact type you require, in the shortest possible time. Rectifier, power, control, photo-electric, cathode ray, transmitting, or receiving . . . in RCA, G.E., Raytheon, Amperex, Eimac, Taylor, and other well known makes.

Save time and work—Call Allied First!
Write, Wire or Phone Haymarket 6800

Engineering Service Available

EVERYTHING IN ELECTRONICS & RADIO

It's faster, simpler to get all your electronic and radio supplies from this one central source. We carry the largest and most complete stocks of parts and equipment under one roof . . . ready for immediate shipment. Besides, our procurement experts are in constant contact with all leading manufacturers. This complete service simplifies and speeds supply of diversified needs.

Helpful
**BUYING
GUIDE**
Available
on Request
Write for it!

ALLIED RADIO

C O R P O R A T I O N

833 W. Jackson Blvd. Dept. 14-C-5 Chicago 7, Illinois

SUPPLIERS OF ELECTRONIC PARTS AND EQUIPMENT TO INDUSTRIAL AMERICA

Electronic Tubes, Rectifiers, Power Supplies, Intercommunicating Systems, Sound Systems, Photo-Cell Equipment, Batteries, Chargers, Converters, Generators, Supplies for Resistance Welders, Fuses, Test Instruments, Meters, Broadcast Station Equipment, Relays, Condensers, Capacitors, Resistors, Rheostats, Transformers, Switches, Coaxial Cable, Wire, Soldering Irons, Microphones, Speakers, Technical Books, etc.

TECHNICANA

[Continued from page 11]

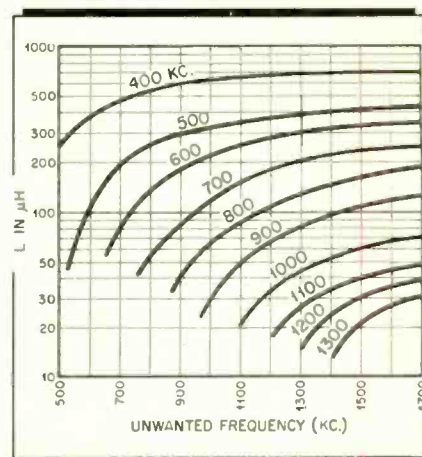

Figure 3

wanted frequency. For lower frequencies there is a boost. This is illustrated by Fig. 2.

The curves of Fig. 3 enable the designer to choose a value of inductance to give boost to the frequencies shown in the block and attenuation to the frequencies shown on the X-axis. These curves are based on an antenna capacitance of 200 μf .

The series wavetrap will give boost to lower frequencies where receivers are usually more sensitive and boost is unnecessary.

The shunt wavetrap will give boost at frequencies higher than the unwanted frequency to which the wavetrap is tuned.

The shunt wavetrap is shown in Fig. 4.

A diagram similar to Fig. 3 is obtained, giving inductance values necessary to reject certain frequencies when higher frequencies are boosted.

The input resistance of the receivers

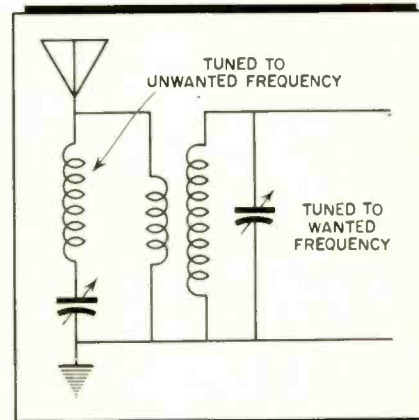

Figure 4



The Greeks gave us a word for it . . . now we give it to *you*

WHEN Sperry first developed its velocity-modulated, ultra-high-frequency tube, the word "KLYSTRON" was registered as the name of the new device.

This name — from the Greek, as coined by scientists of Stanford University — is an apt description of the bunching of electrons between spaced grids within the tube.

"Klystron" is a good name. So good, that it has come into widespread use as the handy way to designate *any* tube of its general type,

whether a Sperry product or not.

This is perfectly understandable. For the technical description of a Klystron-type tube is unwieldy, whether in written specifications, in conversation, or in instructing members of the Armed Forces in the operation of devices employing such tubes.

These conditions have prompted many requests from standardization agencies—including those of the Army and Navy—for unrestricted use of the name Klystron. In the public interest, Sperry has been glad to

comply with these requests . . .

From now on, the name KLYSTRON belongs to the public, and may be used by anyone as the designation for velocity-modulated tubes of any manufacture.

Sperry will, of course, continue to make the many types of Klystrons it now produces, and to develop new ones.

On request, information about Klystrons will be sent, subject to military restrictions.

SPERRY GYROSCOPE COMPANY, INC. GREAT NECK, N. Y.

Division of the Sperry Corporation

★
LOS ANGELES • SAN FRANCISCO • NEW ORLEANS
HONOLULU • CLEVELAND • SEATTLE

GYROSCOPICS • ELECTRONICS • RADAR • AUTOMATIC COMPUTATION • SERVO-MECHANISMS

RADIO

★ MARCH, 1945

13

IT IS BETTER
TO
Give

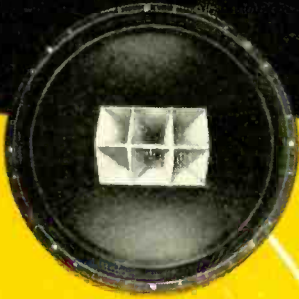

THAN TO RECEIVE

To GIVE a beautiful reproduction of high quality sound from a low bass response of 40 cycles up to a high frequency range of 15,000 cycles plus, will pay broadcasters and manufacturers of home radio, FM and Television receiving sets. The American public is willing to give in proportion to what it RECEIVES. That's why the Duplex, the SPEAKER that REVOLUTIONIZES the methods of sound REPRODUCTION, was perfected.

SEND FOR BULLETINS

ALTEC
LANSING CORPORATION

1210 TAFT BLDG., HOLLYWOOD 28, CALIF.

TECHNICANA

[Continued from page 12]

has the effect, when low, of short circuiting the shunt wavetrap and rendering it ineffective. When the receiver has a high input resistance the series wavetrap will be ineffective. For a nom-

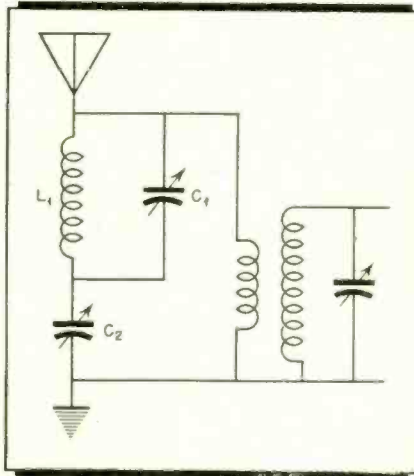

Figure 5

inal input resistance of, say 10,000 ohms, both types of wavetrap are useful, and the type can be selected on the basis of which part of the waveband is to be boosted.

The circuit of Fig. 5 gives boost to two frequencies while rejecting one. In this circuit L, C_1 resonates at a wanted frequency. The combination is inductive and resonates with C_2 to give rejection.

SIGNAL GENERATOR

A cheap and compact signal generator, covering the range from 250 kc to 15 mc, which delivers either a modulated or an unmodulated signal, using

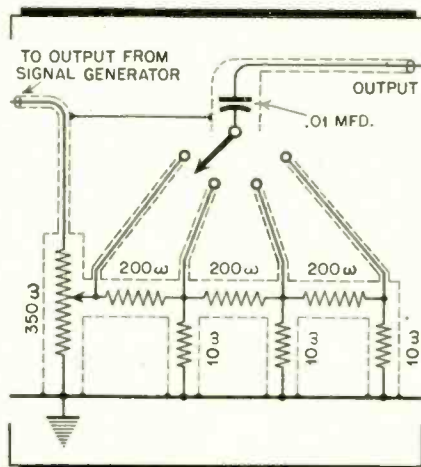

Figure 7

only one tube, is described by Mr. K. W. Mitchell in the February 1945 issue of *Wireless World*. The article is entitled "Modulated Test Oscillator". The circuit is shown in Figs. 6 and 7, the latter showing the output attenuator.

The author gives inductance values and construction of these oscillator coils.

The 6A8G heptode converter employs negative resistance in a transitron circuit, with the oscillator circuit using grid #4, grid #2, and the anode. The AF modulation circuit uses grids #1 and #3.

The use of harmonics will permit operation up to 30 mc.

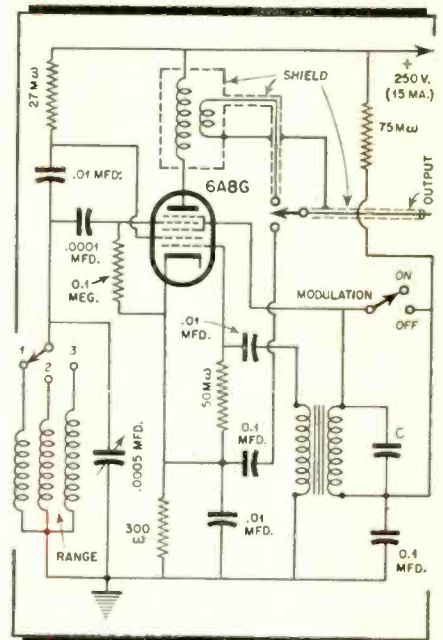

Figure 6

NOISE IN AMPLIFIERS

★ The relative advantages of amplifier circuits employing normal plate load output, a cathode follower, or a grounded grid, must be considered in relation to the signal-to-noise ratio in the output as well as on the basis of circuit characteristics, according to Mr. R. E. Burgess, writing in the February 1945 issue of *Wireless Engineer*. Mr. Burgess' article is entitled "Signal/Noise Characteristics of Triode Input Circuits".

The author first points out that the triode is superior to a pentode on a signal/noise basis, since there are additional shot-effect fluctuations in the pentode due to sharing of the space current by two electrodes.

The equivalent noise resistance of a normal amplifier (plate load) is expressed by the equation

$$R_n = R_o + \frac{R_z}{g^2 |Z_e|^2}$$

in which R_o is the noise resistance of the

[Continued on page 16]

KNOW-HOW BEGINS AT HOME

SPECIAL tools, ingenious manufacturing devices, and elaborate test equipment which makes delicate measurements almost as easy as telling the time . . . these things seem to interest our visitors particularly. We are always proud to point out that most of these aids to swift, precise production were developed by our own men and women.

There's a world of skill and experience at Con-

necticut Telephone & Electric Division . . . born of nearly fifty years of practice and progress. This know-how isn't confined to our engineering departments, either. Some of our most useful suggestions come straight from the production lines.

Purchasers of C. T. & E. products benefit from this skill and ingenuity . . . in better, more advanced devices, produced faster, for less.

CATHODE RAY SCREEN TESTER

Tests a telephone or radio headset for response over the entire range of audible sound in a matter of seconds, and charts the results on a television-type screen. Developed for our own use by our own people, this instrument has been a priceless aid in maintaining high quality and quantity in war production for the U. S. Signal Corps and Air Corps.

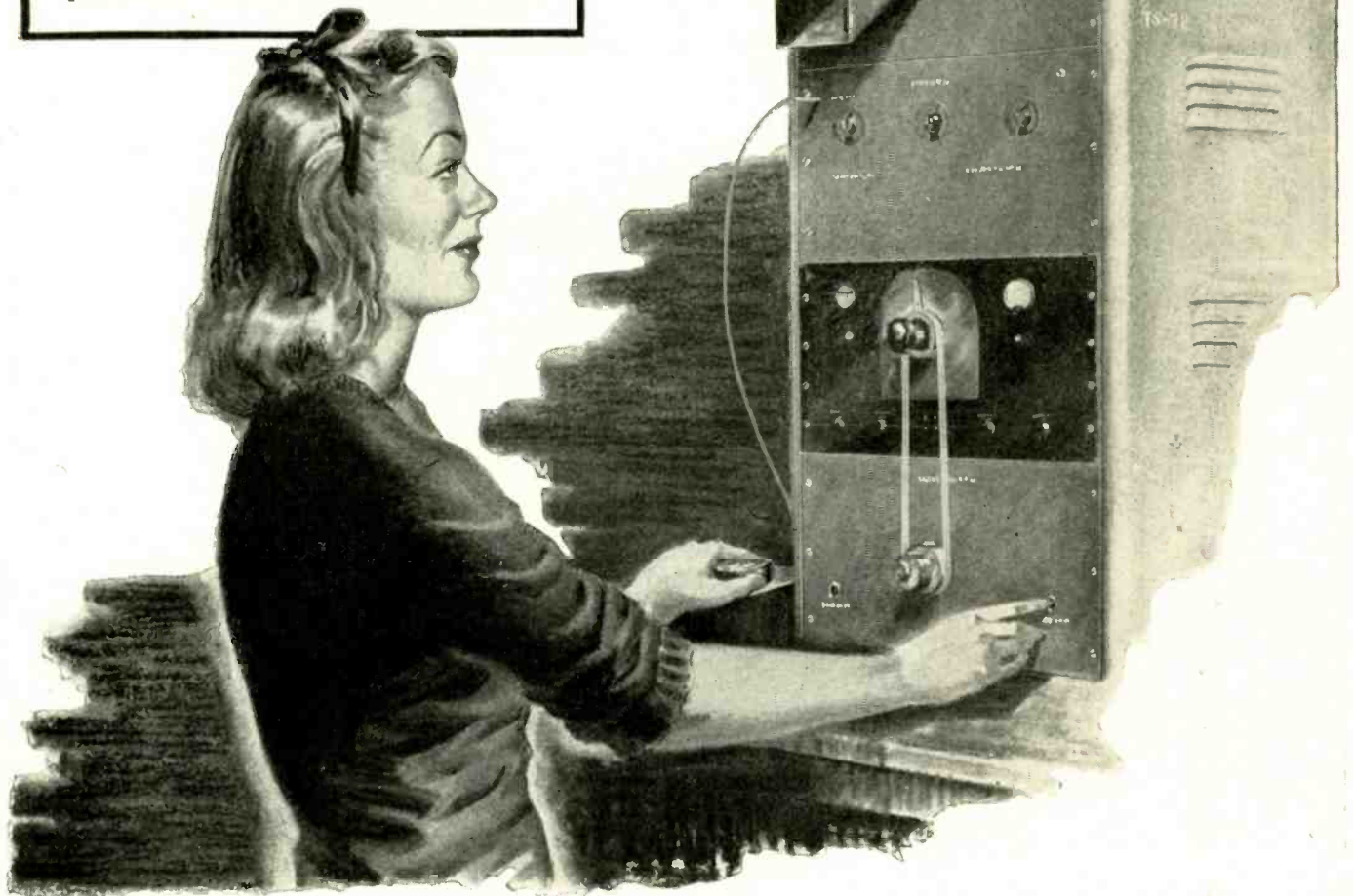

CONNECTICUT TELEPHONE & ELECTRIC DIVISION
GREAT AMERICAN INDUSTRIES, INC. • MERIDEN, CONN.

TELEPHONIC SYSTEMS • SIGNALLING EQUIPMENT • ELECTRONIC DEVICES • ELECTRICAL EQUIPMENT
HOSPITAL AND SCHOOL COMMUNICATIONS AND SIGNALLING SYSTEMS • IGNITION SYSTEMS

TECHNICANA

(Continued from page 14)

tube alone, and the second term is due to thermal noise in the plate load Z_2 having a noise resistance R_2 . The tube slope in ma/v is represented by g . The above expression also holds for a cathode follower. For the grounded-grid amplifier the first term, R_0 , becomes $(\mu)^2$ R_0 , so the contribution of the $(\mu + 1)$ tube to the equivalent noise resistance

of the amplifier is practically the same for each case.

The thermal noise contributes substantially to the total noise. The loss in signal-to-noise ratio is dependent upon the noise resistance of succeeding tubes, V , as illustrated in Figs. 8 and 9.

In Fig. 8 the loss in S/N ratio is shown (a), for a direct connection of signal source to tube V , and (b), with the case of a normal triode amplifier. The loss is seen to depend upon the ratio of noise resistance in tube V to noise resistance in the amplifier, which in the case of Fig. 8 was 500 ohms.

Fig. 9 illustrates loss in S/N ratio for (a) grounded-grid amplifier, (b)

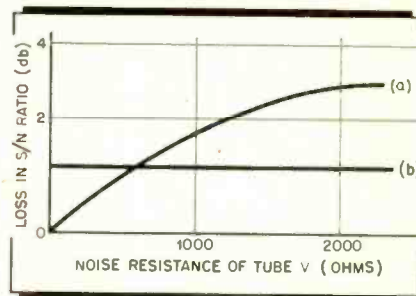

Figure 8

an ideal transformer input with optimum coupling, and (c) direct connection to V .

Coupling via an ideal transformer will produce greater S/N ratio loss than by direct connection if the impedance of

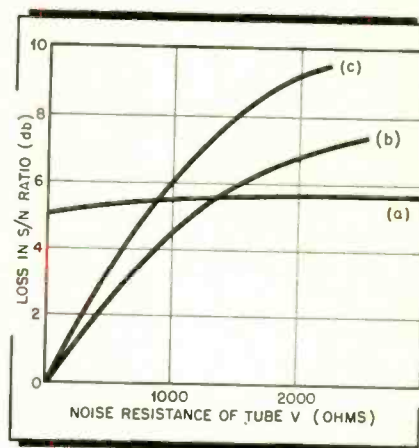

Figure 9

the transformer secondary is less than four times the resistance of the source.

The triode amplifier is superior to both the ideal transformer and direct connection when the succeeding tube V has a high noise resistance, as illustrated by the Figs. 8 and 9.

TRIANGULAR TOWER

Light weight of individual parts and simplification of design contribute to the facility with which the Harco "Blizzard King" radio or structural tower can be erected. The average weight of members is 5.3 pounds, while the heaviest tips the scales at only eight pounds. Bolt and sleeve construction makes possible the erection of these triangular towers, in lengths from 90 to 425 feet, by unskilled labor.

A four-man crew is sufficient for all towers, and the erection time runs from 10 hours for the 90-foot design to 50 hours with the 425-foot giant.

Full details can be obtained from the Harco Steel Construction Co., Inc., 1180 East Broad Street, Elizabeth 4, New Jersey.

One of a series of Electro-Voice advertisements explaining in detail the applications and specifications of Electro-Voice microphones



... a general-purpose dynamic microphone with an exceptionally wide and flat frequency response—for both indoor and outdoor speech and music pick-up—is required ...

Electro-Voice MODEL 630

This versatile, moderately priced microphone is excellent for public address, all types of dispatching and call systems, paging systems, churches, auditoriums, hotels, recording studios and broadcast remote pick-ups. Though somewhat lighter in weight, it is a sturdy microphone, built with typical Electro-Voice care to serve satisfactorily over a long period of time. Attractively styled, it is finished in lustrous chromium. The Model 630 is unusually flat through lower and middle register, rising 5 db on upper frequencies for added crispness of speech. Operates efficiently in salt air and humidity.

OUTPUT LEVEL: Power ratings: 54 db below 6 milliwatts for 10 bar pressure. Voltage rating (high impedance) 7 db above .001 volt/bar, open circuit. Voltage developed by normal speech (10 bars): .0224 volt.

FREQUENCY RESPONSE: 40-8000 c.p.s., with slightly rising characteristics.

WEIGHT: 1½ pounds.

TILTABLE HEAD: 90° tiltable head for directional or non-directional operation.

CABLE CONNECTOR: Built-in cable connector permits movement of head without moving the cable.

CASE: Built of highest quality, high impact pressure cast metal.

TRANSFORMER CORE: Nickel alloy; hydrogen annealed; low capacity windings.

DIAPHRAGM: Fine quality, heat-treated duralumin; corrosion-inhibited for use in salt air and humidity.

CONDUCTOR CABLE: 20-ft. well shielded cable and connector; low impedance balanced to ground.

HI-Z (DIRECT TO GRID) or 50, 200, 250 and 500 ohms.

SCIENTIFICALLY DESIGNED GRILLE: Reduces wind noise.

ON-OFF SWITCH: Standard ¼" — 27 stand coupler.

MAGNETIC CIRCUIT: Employs Alnico V and Armeo magnetic iron.

List Price, \$30.00

Contact your nearest radio parts distributor today. His knowledge of Electro-Voice microphones may aid you in selecting the appropriate type for your individual need. He may also be an important factor in speeding your order.

THE RED CROSS
ASKS YOUR HELP
... GIVE GENEROUSLY

Electro-Voice MICROPHONES
ELECTRO-VOICE CORPORATION • 1230 SOUTH BEND AVENUE • SOUTH BEND 74, INDIANA
Export Division, 73 East 42nd Street, New York 17, N. Y. • A. T. & A. T. Cable, AVIOE



*Seaworthy!...
and IRC-Worthy*



**GRADE 1 — CLASS 1
RESISTORS**

Exhaustively tested for dependable performance and sound construction, IRC's Type GRW *GRADE 1—CLASS 1 RESISTORS* are now available. Only after every requirement of Army-Navy specification Jan-R-26 had been met or surpassed would our Engineering Department approve this product for the applications for which it is designed.

Resistant to salt water immersion following thermal shock, they are capable of continuous efficient operation at a total temperature of 275° C. (ambient plus rise).

Made in 7 standard sizes with power ratings from 15 to 140 watts and resistance ranges of from 0.1 to 46000 ohms, the GRW's are enclosed in special heat-treated glass for optimum strength. Non-corrosive ferrules are hermetically sealed to the tube with pure lead. Nickel alloy leads pass through the centering devices and are welded to the outer ferrule cups. All resistors are *space wound*.

These IRC *GRADE 1—CLASS 1's* are engineered to "take it" far beyond normal requirements and can stand transverse loads as high as 100 pounds without failure or damage of any kind.



Write today for special Engineering Bulletin containing dimension drawings, temperature rise and de-rating curves as well as other technical data.

**INTERNATIONAL
RESISTANCE CO.**

Dept. 7 C

401 NORTH BROAD STREET, PHILADELPHIA 8, PA.

IRC makes more types of resistance units, in more shapes, for more applications than any other manufacturer in the world.



AN 3155 Resistor

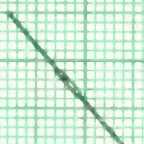

BTE—¼ watt Insulated Resistor

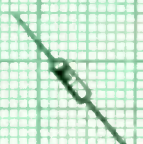

BTA—1 watt Insulated Resistor



Grade 1—Class 1 Resistors

COMING...COMING...COMING...

..with Built-in Resistors for use with NE51 NEON LAMPS!

THE far greater economy, efficiency, and reliability of the new NE 51 NEON LAMPS has created a great deal of interest in our newest NEON light assemblies. Drake No. 50N and No. 51N assemblies are shipped *complete* with NE 51 Neon Lamps . . . all ready to connect to 105 to 125 volt sources. Attractive plastic shields that cover and protect the Neon lamps will be ready about April 1945. Consider Drake Patented Neon Assemblies . . . the sturdy units that save power (1/25 watt) — last longer — (3000 hrs.) and have a wider voltage range.



SOCKET AND JEWEL LIGHT ASSEMBLIES

DRAKE MANUFACTURING CO.

1713 WEST HUBBARD ST., CHICAGO 22, U.S.A.

BOOK REVIEWS

RADIO WAVES AND THE IONOSPHERE, by T. W. Bennington, published by WIRELESS WORLD, Iliffe & Sons, Ltd., Dorset House, Stamford Street, London, SE1, England, 1944. 81 pages, 6/— . A booklet describing the properties of the different layers of the ionosphere and what happens to radio waves of different wavelengths. It explains clearly what happens to each layer at different times of the day and in different seasons. The subject of long-distance transmission is taken up, showing the reasons for skip-distance and why the working range at any one frequency varies with the time of the day and with the season.

Chapter headings: 1. Ground waves and sky waves; 2. The sun and the ionosphere; 3. How the ionosphere is sounded; 4. Ionosphere variations; 5. Long-distance transmission; 6. Ionosphere disturbances and other abnormalities.

The text is simply and clearly written and should prove helpful to those who wish to understand the subject.

HOW TO PASS RADIO LICENSE EXAMINATIONS, 2nd edition, by Charles E. Drew. Published by John Wiley and Sons, 440 Fourth Ave., New York, N. Y. and by Chapman & Hall, Ltd., London, 1944. 320 pages, \$3.00. This book, written in question-and-answer form, is intended as a review for persons preparing for a government examination for commercial radio operator of any grade. It lists the kind of questions generally asked by the inspector with the correct answers. In addition, there are numerous discussions following some of the answers, giving the reasons and some of the theory which is not properly a part of the answer. These were included because it would otherwise be impossible to give this information without creating confusion.

The book is divided into six chapters, one for each "element" in accordance with the government requirements. There are several appendices which include extracts from radio regulations, abbreviations, Q-signals, the Continental Morse Code and miscellaneous information.

The book will be found helpful to anyone who expects to apply for a "ticket". To your reviewer, it seems that some of the questions are worded in that they are ambiguous, and some of the answers are not quite kosher, either. Some questions evidently do not mean what they say; if they are actually put like that

(Continued on page 23)



THERMOSTATIC METAL TYPE DELAY RELAYS PROVIDE DELAYS RANGING FROM 1 TO 120 SECONDS

Other important features include:—

1. Compensated for ambient temperature changes from -40° to 110° F.
2. Contact ratings up to 115V-10a AC.
3. Hermetically sealed — not affected by altitude, moisture or other climate changes . . . Explosion-proof.
4. Octal radio base for easy replacement.
5. Compact, light, rugged, inexpensive.
6. Circuits available: SPST Normally Open; SPST Normally Closed.

WHAT'S YOUR PROBLEM? Send for "Special Problem Sheet" and Descriptive Bulletin.

AMPERITE CO. 561 BROADWAY
NEW YORK 12, N. Y.

In Canada: Atlas Radio Corp., Ltd.
560 King St. W., Toronto





**COILS, NAW, MISTER, DERE AIN'T NO SHORTAGE.
ALBION CAN SHIP ALL DE COILS YOU NEED!**

SUPER-QUALITY COILS AT REASONABLE PRICES

More and more every day, the industry is turning to Albion for fast, quality and quantity production of coils, chokes, and transformers. That's because here you benefit from the unbeatable combination of management "know how," skilled workmanship, streamlined facilities, and central location. Your requirements will be given prompt and thoughtful attention.

**ALBION
COIL COMPANY**

ALBION, ILLINOIS

R. F. AND TRANSMITTING COILS AND CHOKES;
I. F. TRANSFORMERS

hallicrafters equipment covers the spectrum

● Hallicrafters equipment covers the radio spectrum. From low to ultra high frequencies there is a Hallicrafters receiver ready to meet your special requirements. Although certain equipment operating in the ultra high frequencies cannot be described at present for security reasons, the characteristics of Hallicrafters standard line of receivers may be disclosed. This line includes:

Model S-37. FM-AM receiver for very high frequency work. Operates from 130 to 210 Mc. Highest frequency range of any general coverage commercial type receiver.

Model S-36. FM-AM-CW receiver. Operates from 27.8 to 143 Mc. Covers old and proposed new FM bands. Only commercially built receiver covering this range.

Model SX-28A. Operates from 550 kc to 42 Mc continuous in six bands. Combines superb broadcast reception with the highest performance as a versatile communications receiver.

Model S-22R. Completes Hallicrafters coverage in the lower end of the spectrum. Operates from 110 kc to 18 Mc in four bands. A.c./d.c. operation.

BUY A WAR BOND TODAY!



hallicrafters

THE HALLICRAFTERS COMPANY • MANUFACTURERS OF RADIO AND ELECTRONIC EQUIPMENT • CHICAGO 16, U. S. A.

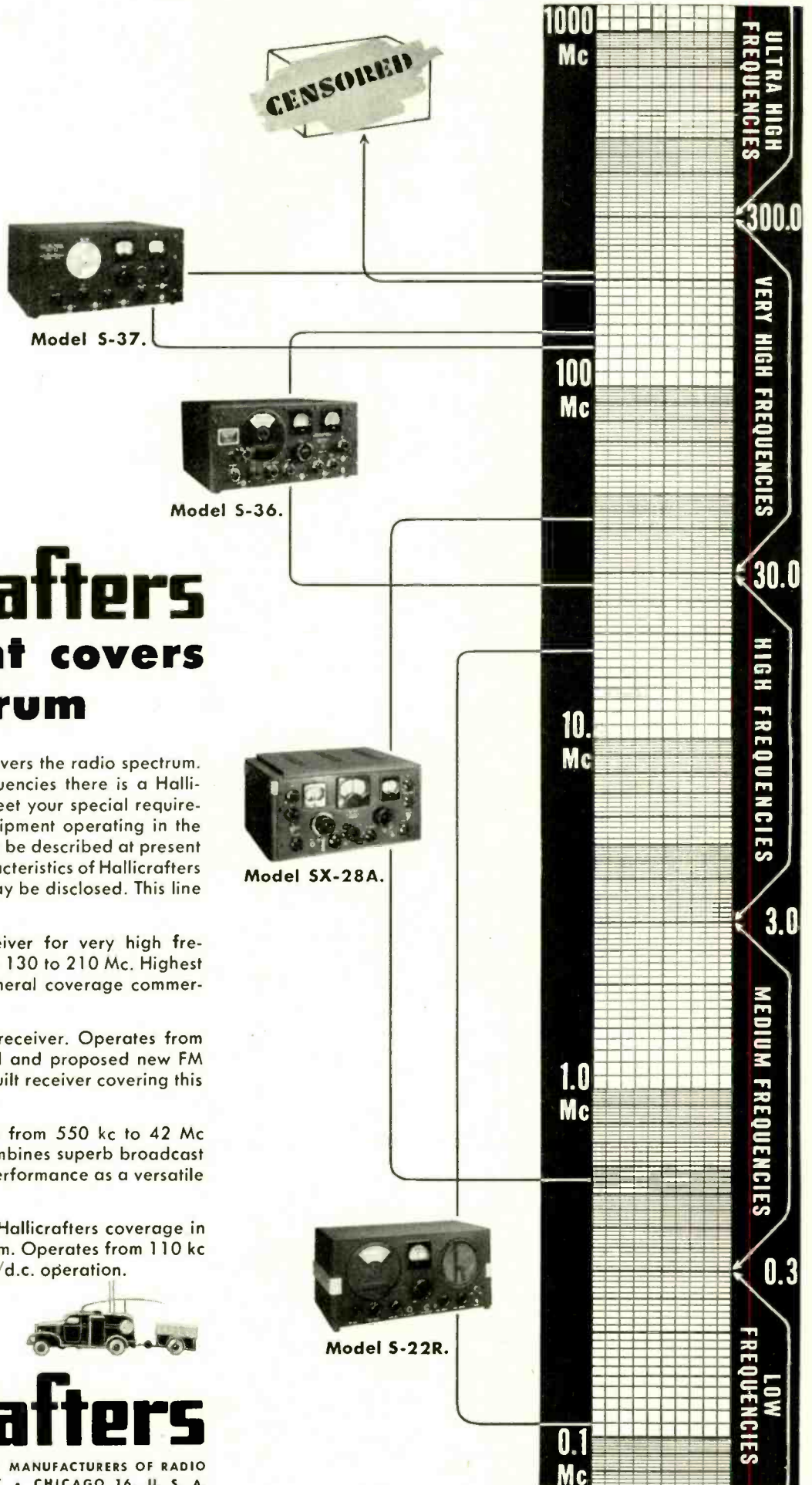

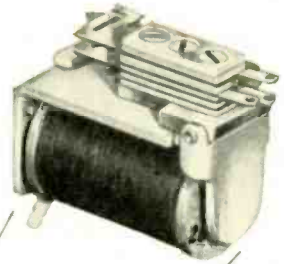

**When a lot of stamina
must fit a little space**



IF SPACE requirements dictate a small relay—and service conditions a powerful one... here's the relay to fit your needs. It's the Automatic Electric Class "S" Relay—tiny in size, light in weight, but dependable and packed with power.

Class "S" Relays have been designed especially to meet the exacting conditions of service on fast, modern aircraft. They offer a combination of features never before found on any relay, large or small. For example:

1. Vibration-resistance is not just "added on"—it's designed right into Class "S" Relays. And they withstand with a large margin of safety the most rigorous operating tests of the Signal Corps and the Air Forces.
2. A unique spring design provides high contact pressure within small space limits.
3. An added assurance of reliability is provided by twin contacts.
4. The new type of pin-pivoted armature with full length bearing provides the Class "S" Relay with exceptionally long life even under the toughest conditions.

The Automatic Electric Catalog gives full details. Write for your copy.



Relays

AND OTHER CONTROL DEVICES

by **AUTOMATIC
ELECTRIC**

AUTOMATIC ELECTRIC SALES CORPORATION

1033 West Van Buren St., Chicago 7, Ill.

In Canada:

Automatic Electric (Canada) Limited, Toronto

A MODERN SYLLOGISM

MAJOR PREMISE:

Bell Telephone System serves the American Public.



MINOR PREMISE:

Bell Telephone Laboratories develop the facilities of the Bell System.

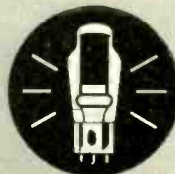

CONCLUSION:

Therefore, Bell Laboratories serve the American Public.

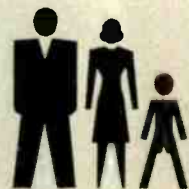
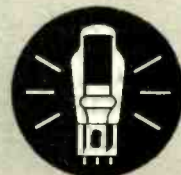

And that is the *raison d'être* of the Laboratories. For the Bell Telephone System, the Laboratories carry on research studies in all the sciences and development work in all the engineering arts that relate to electrical communication.

For the Western Electric Company, the manufacturing unit of the System, the Laboratories develop

equipment, prepare specifications for its construction, and engage in various engineering activities.

For the Armed Forces of the United States, under contracts of the Western Electric, the Laboratories have undertaken more than a thousand development projects — many with spectacular effect upon our enemies.



BELL TELEPHONE LABORATORIES *explore and invent, devise and perfect for our Armed Forces at war and for continued improvements and economies in telephone service.*

BOOK REVIEWS

(Continued from page 18)

by the Government, it is unfair to the applicant. For instance, see page 16, "Question 2.31. What single instrument may be used to measure (a) Electrical resistance? (b) Electrical power? (c) Electrical current? (d) Electromotive force? Answers: (a) Ohmmeter (b) Wattmeter (c) Ammeter (d) Voltmeter."

But these are *four different instruments*, and didn't the question ask for a *single instrument*? The applicant who wants to answer this question correctly is at a disadvantage.

Question 4.155 on page 181 asks what are Lissajous figures? The answer given is unfortunately too long to quote here but the author gives the impression that any pattern on a cathode-ray tube is a Lissajous' figure. In fact, the greater part of the answer deals with the operation of the tube itself. It is not made clear that Lissajous' figures are obtained only when comparing two sinusoidal voltages whose frequencies have an integral ratio. These figures

can also be obtained mechanically without a cathode-ray tube (See Tesla's original writings).

ULTRA - HIGH - FREQUENCY RADIO ENGINEERING, by W. L. Emery. Published by The Macmillan Company, 60 Fifth Ave., New York, N. Y., 1944. 295 pages, \$3.25. The text of this book was developed from lecture notes for an ESMWT course, given by the author on "Ultra-High-Frequency Techniques". It was written for senior electrical engineering students and assumes considerable knowledge of mathematics, communication and electronics on the part of the reader.

The subjects covered are not restricted to ultra-high frequencies but include other subjects. The Chapter headings are: I—Introduction; II—Voltage-regulated power supplies; III—Electronic switching and synchronization; IV—Cathode-ray tubes and sweep circuits; V—Amplifiers; VI—Square-wave testing and transient response; VII—Ultra-high-frequency circuit elements; VIII—Oscillators; IX—Modulation and detection; X—Radiation; XI—Wave Guides.

(Continued on page 26)

**Performance
Engineered
TO THE
Application**

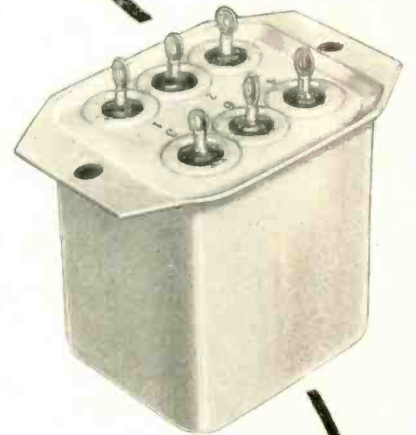

Hermetically sealed, output transformer. Terminals constructed of Pyrex glass with Kovar electrodes and metal collars. Designed and constructed to pass 5 cycle immersion test.



This type T-7029 Filament Transformer with H.V. Insulators is one of many designs we have produced. Send your specifications.

THE ACME ELECTRIC & MFG. CO.
CUBA, NEW YORK • CLYDE, NEW YORK

Acme Electric
TRANSFORMERS

Another DX FIRST!



For more than a year DX Crystals have been automatically deep-etched by a new process. Both the method and machines were perfected by DX Engineers so that all DX Xtals can have the nth degree of stability and endurance necessary to wartime operation.

Think about DX Products for your new receivers and transmitters.

**DX
XTALS**

the heart of a good transmitter

DX CRYSTAL CO.

GENERAL OFFICES: 1200 N. CLAREMONT AVE., CHICAGO 22, ILL., U. S. A.

*A complete, compact test-bench
in a single unit!*

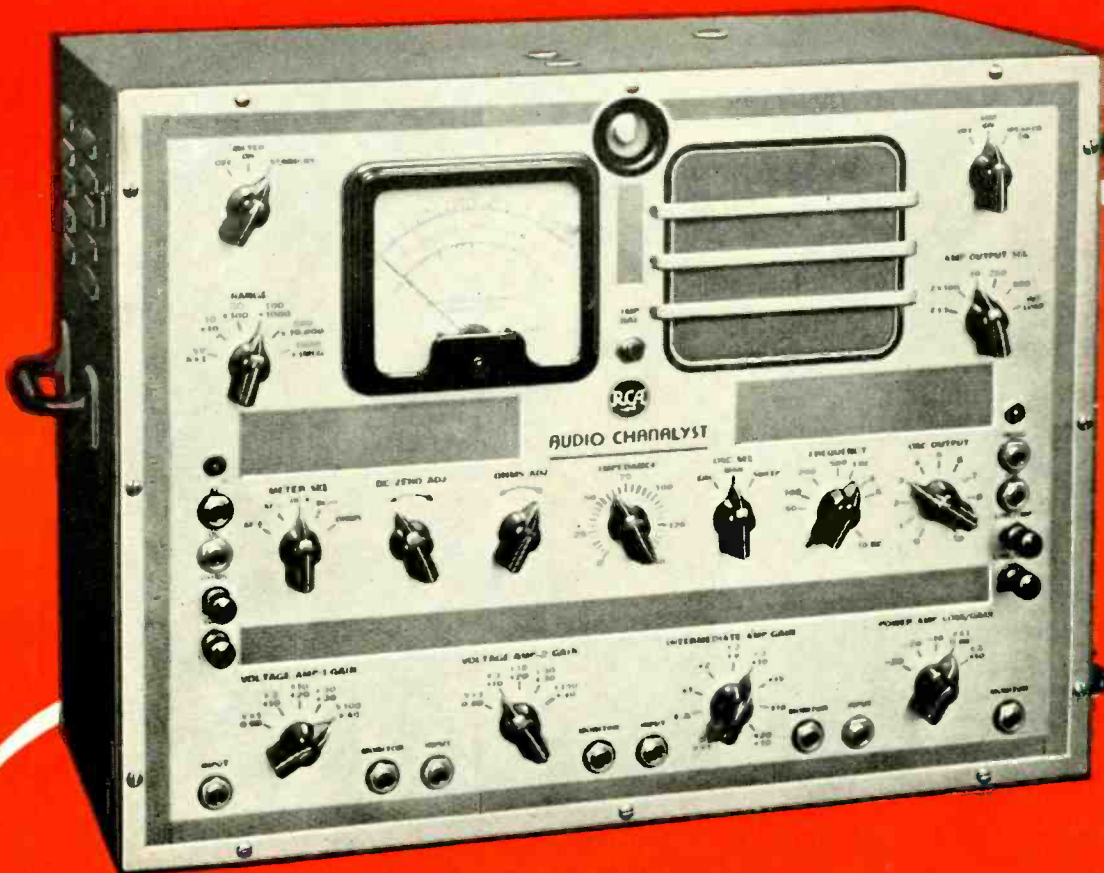

...the new **RCA 170-A AUDIO CHANALYST**
that tests everything—from microphone to multiple speakers

Available on rated orders
FOR COMPLETE INFORMATION
Use The Coupon

Test & Measuring Equipment
Dept. 110E
Radio Corporation of America,
Camden, New Jersey
Please send me complete information
about the new RCA 170-A
Audio Chanalyst.

Name.....
Company.....
Street.....
City..... State.....
97-6136-110

● With the 170-A you can systematically test any sound system completely for failure to operate, weak output, interrupted operation, and distorted or noisy output.

● You can check the presence, absence, or character of a signal throughout its path—from source to load.

● You can check gains or losses, measure component values, and test the voltages of any item supporting or controlling the signal.

● You can narrow down poor performance to its cause, and locate the defective part in an amazingly short time.

● You can use it to solve signal-interruption problems by multi-channel monitoring.

● In an emergency, you can use the RCA Audio Chanalyst to substitute for defective amplifiers by bridging the signal through it, and thus around the defect.

BUY MORE WAR BONDS



RADIO CORPORATION OF AMERICA

RCA VICTOR DIVISION • CAMDEN, N. J.
In Canada, RCA VICTOR COMPANY LIMITED, Montreal

*they said
it couldn't
be done...*



and again...
**THEY SAID
IT COULDN'T
BE DONE...**



Hytron's telescoping of receiving tubes to BANTAM GT size was at first considered impracticable. Development of the BANTAM JR. was another impossibility to be proved possible. This first sub-miniature was a tiny tube whose diameter was about that of your little finger — and it was a pentode at that! As a production tube it just didn't seem to make sense.

Encouraged by hearing-aid manufacturers eager to gain the additional sensitivity of the vacuum tube, Hytron sweated it out for two long years. Operators were trained to assemble the minute parts under

magnifying glasses. A simple reversal of the conventional stem made baseless tubes possible. Problems of obtaining suitable vacuum with such small bulbs, were licked.

Finally in 1938, Hytron introduced the first successful sub-miniature. Tiny but rugged despite a hair-like filament and a diminutive mount structure, its low current drain and compactness made the BANTAM JR. a natural for all kinds of portable equipment, hearing aids, and military electronic devices. After the war, watch for even smaller and better Hytron sub-miniatures.



OLDEST EXCLUSIVE MANUFACTURER OF RADIO RECEIVING TUBES

HYTRON
CORPORATION
ELECTRONIC AND
RADIO TUBES

SALEM AND NEWBURYPORT, MASS.



BUY ANOTHER WAR BOND

EVERYDAY IS WASHDAY AT Triplett

The special equipment and solutions with which jewels are washed typify the Extra Care provisions that are routine in Triplett plants in the making of fine electrical measuring instruments. Through them Triplett maintains in mass production the hand-

made quality of fine instruments. Extra Care in our work puts Extra Value in your Triplett Instruments.

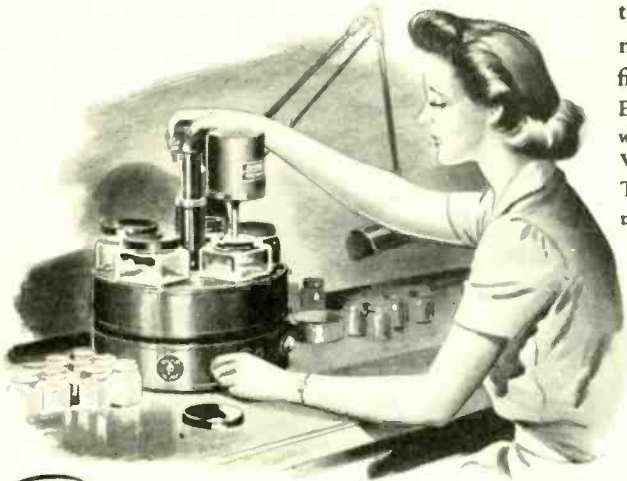

*Precision first
...to last*

Triplett

ELECTRICAL INSTRUMENT CO. BLUFFTON, OHIO



BOOK REVIEWS

(Continued from page 23)

Each chapter concludes with a list of problems (without answers), one or more experiments to be performed and a list of references. Many of the illustrations of waves and fields are in two colors.

The author has a different viewpoint in presenting some of his subjects this may be easier to follow for the reader. However, he does not bring this gift to bear on the most difficult subjects, such as radiation and wave-propagation.

Although the text includes all the various elements that go with ultra-high frequency, every kind of oscillator, cavity resonators, wave guides, etc., it still does not satisfy. There are rather too many subjects and too little on each of them. In addition, valuable space is used up by covering material that is already well covered in conventional books on radio engineering.

This book is useful for the classroom where a teacher can supply the missing information. It may also be of interest to the engineer who already has some knowledge of the subject and who can consult several other books. The description of the experiments, the generous bibliography and some of the novel treatment make it worth while. To the man who has little previous knowledge and who can buy but one book on ultra-high frequency, this is not recommended.



Thomas A. White

After 17 years service, Thos. A. White has been made president and general manager of Jensen Radio Manufacturing Co., located at 6601 So. Laramie Ave., Chicago, Illinois. Tom White joined Jensen in 1928 in the capacity of sales manager after acquiring an interest in the company.

In his newest capacity, Mr. White assumes entire direction of this nationally known company which is now devoted to the manufacture of loud speakers and sound reproducers for the war effort. He replaces W. E. Maxon who retired at his own request.

Tom White is a well-known figure in the radio industry, having been connected with that and the electrical field since leaving the University of Minnesota, College of Electrical Engineering in 1921.

TOUGH!



Cinaudagraph Speakers are made to take the tough raps. This is the built-in result of better manufacturing experience. Look at the record of achievement and you'll put Cinaudagraph Speakers at the top of your list.

Watch Cinaudagraph Speakers After Victory!



Cinaudagraph Speakers, Inc.

3911 S. Michigan Ave., Chicago
Export Div., 13 E. 40th St., New York 16, N. Y.

"No Finer Speaker in all the World"

POWER

HIGH FREQUENCY HEATING
INTERNATIONAL BROADCAST

FM

The Most Powerful High-Frequency Tube

200 Kilowatts—developed especially for high-power, high-frequency broadcast and industrial applications.

Into this development has gone all the knowledge and experience of the tube-building art that make the name Federal stand for dependability—a reputation earned by more than 35 years of service in the electronics field.

Federal tubes are built for long life . . . produced with all the care and precision of fine craftsmanship.

Federal always has made better tubes.



Federal Telephone and Radio Corporation



Newark 1, N. J.

transformer designs

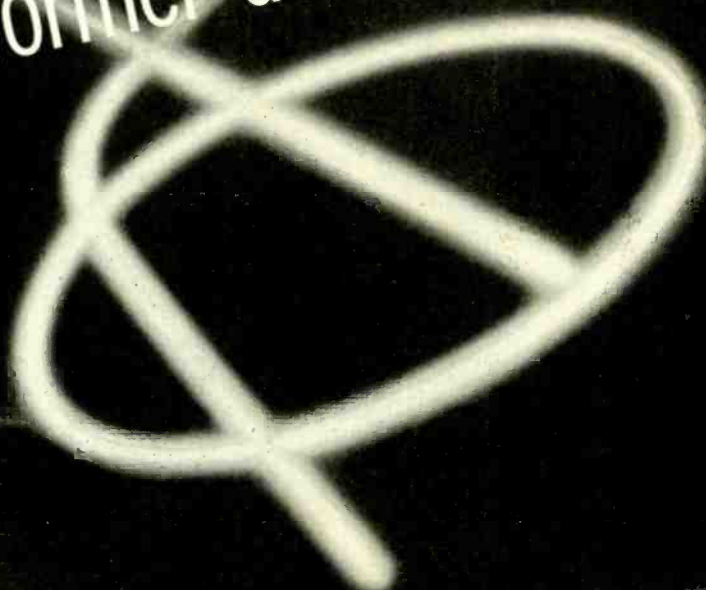

FOR *Every* ELECTRONIC NEED

Although specialists in the design and quantity production of transformers for a quarter century, the demands of the past few years have brought about many developments. The requirements for military and essential industry purposes have multiplied many-fold with further emphasis on exactness and uniformity.

Transformer specialists before the War—great strides have been made in anticipating and meeting requirements of greatly varied character that have multiplied many-fold for military and essential industrial purposes.

Reports from all over the world emphasize the reliability of Jefferson Electric Transformers. Wherever used—on land, sea or in the air—in the frozen North, or hot, dry or humid tropics, the value of "quality" is being demonstrated daily.

Now is a good time to study your transformer requirements and let Jefferson engineers make recommendations that will save your time later.



JEFFERSON ELECTRIC COMPANY

JEFFERSON
ELECTRIC

BELLWOOD (SUBURB OF CHICAGO) ILLINOIS

IN CANADA: CANADIAN JEFFERSON ELECTRIC CO. LTD., 384 PAPE AVENUE, TORONTO, ONT.

YOU CAN GET IT
Now
IN VOLUME!

MF-66 Glass base material is ready! Material, facilities and techniques are at last available for the production in quantity of the new Formica grade which is superior to all other grades in low losses at high frequencies. This material, created to extend the useful working range of laminated plastics, is ready for prompt shipment to high priority customers.

THESE ARE ITS CHARACTERISTICS:

<p>MECHANICAL STRENGTH <i>(average values)</i></p>			<p>WATER ABSORPTION <i>(average values)</i></p>
<p>TENSILE <small>(non-directional)</small></p> <p>10,000 P.S.I.</p>	<p>FLEXURAL <small>(flatwise)</small></p> <p>14,000 P.S.I.</p>	<p>COMPRESSIVE <small>(flatwise)</small></p> <p>42,000 P.S.I.</p>	<p>24 HRS. IMMERSION AT 25°C</p> <p>SAMPLE: 3" x 1" x 1/8"</p> <p>0.15%</p>
<p>DIELECTRIC STRENGTH <i>(average values)</i></p> <p>SHORT TIME METHOD 1/16" SHEET</p> <p>450 V.P.M.</p>	<p>DIELECTRIC PROPERTIES <i>(average values)</i></p>		
	<p>POWER FACTOR</p> <p>1 kc. 1 mc. 30 mc.</p> <p>.015 .011 .018</p>	<p>DIELECTRIC CONSTANT</p> <p>1 kc. 1 mc. 30 mc.</p> <p>4.9 4.7 4.6</p>	

Grade MF-66 is recommended for radio and radar coil forms, antenna bases, terminal strips and molded parts.

Fungus resistance of MF-66 is outstanding due to the absence of cellulose. The material is readily machinable to close tolerances into strong, shock-resisting in-

ulating parts. Its low water absorption insures high electrical and dimensional stability in humid climates. Ask for quotations!

THE FORMICA INSULATION COMPANY
 4670 Spring Grove Ave., Cincinnati 32, Ohio

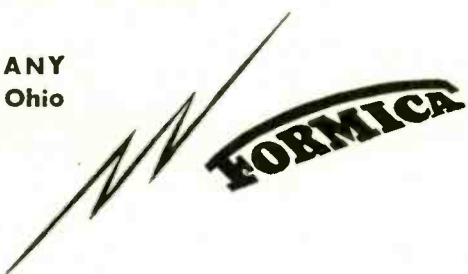

"BIG THREE" MYCALEX PRODUCTS

Answer Military Needs for Advanced Electronic Insulation...and Afford New and Wide Horizons for Post-war Product Improvement

1

MYCALEX
400



A general purpose insulation, especially fitted for high frequency applications; combines low loss factor with machinability to close tolerances, impermeability to water and oil; not subject to distortion below 700° F. Free of carbonization. Approved by Army and Navy as Grade L-4 insulation. Fabricated to your specifications.

2

MYCALEX
K

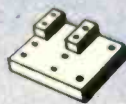

A series of improved capacitor dielectrics, with dielectric constant *selectable* from 8 to 15. Available in the form of large sheets (14"x18"), or long rods 1/4" to 1" in diameter. Low power factor and high dielectric strength. Ideal for use in equipment with variable capacity. MYCALEX K-10 approved by Army and Navy as Grade H1C5H4 Class H material (JAN I-12). Fabricated to your specifications.

3

MOLDED
MYCALEX



A low-loss, high temperature injection molded insulation which can be formed into intricate or irregular shapes, with or without metal electrodes or metal inserts molded in. Adaptable to high production rates and can be sold at moderate prices.



We have plant facilities to fabricate MYCALEX parts to your order. Send for detailed characteristics and specifications of any or all three grades of MYCALEX.

MYCALEX CORPORATION
OF AMERICA

Plant and General
Offices
Clifton, N. J.

Executive Offices
30 Rockefeller Plaza
New York 20, N. Y.

"OWNERS OF 'MYCALEX' PATENTS"

ONE of the formulas commonly used for the calculation of inductance is the familiar Wheeler equation

$$L = \frac{r^2 n^2}{9r + 10l} \dots\dots\dots (1)$$

- where n equals number of turns
- r equals mean radius of the coil in inches
- l equals mean length of the coil in inches
- L equals inductance in microhenries

The above formula is convenient and easy to use when it is desired to find the inductance of a coil whose physical constants are already known. However, in many problems it is necessary to design a coil to give a desired value of inductance. In that case formula (1) is difficult to use as the length (l) depends directly on the number of turns (n), and as both occur in the equation, a system of trial and error is usually used in solving for (n) and (l) when (L) is given.

In most cases of inductance calculation the diameter of the coil form and wire size are determined by practical considerations, while the amount of inductance needed has been previously determined by circuit requirements.

By rewriting equation (1) in terms of the known quantities and solving for (N) by means of the quadratic equation the following general formula is obtained:

$$N = \frac{20L + \sqrt{400L^2 + 18(D+d)^2 A^2 L}}{(D+d)^2 A} \dots\dots\dots (2)$$

- where L equals inductance in microhenries
- D equals diameter of coil form in inches
- d equals diameter of conductor, including its insulation, in inches
- A equals number of turns per inch
- N equals number of turns

The term $(D + d)$ is the mean diameter, and with close winding the term (A) is the reciprocal of (d) .

A manufacturer's table of various wire sizes (d) and corresponding turns per linear inch (A) for close-wound coils is given in Table 1. With spaced winding the term (A) is used according to the specific winding specifications given.

Formula (2) is accurate to within one per cent when the total length of winding (l) is greater than .4 of the mean diameter.

A good rule to use in coil design is to make the length of the coil about twice its diameter. This results in an economical coil shape and also a relatively good Q , which is usually an important factor to be considered.

Notes on INDUCTANCE CALCULATION

WILLIAM VISSERS, JR.

A simplified method of designing coils to meet a required inductance

#	ENAMEL		S.C.C.		D.S.C.		D.C.C.	
	A	d	A	d	A	d	A	d
16	18.9	.05291	17.9	.05586	18.2	.05494	16.5	.06060
17	21.2	.04716	19.8	.05050	20.2	.04950	18.2	.05494
18	23.7	.04237	22.0	.04545	22.5	.04444	20.0	.05000
19	26.5	.03773	24.4	.04098	25.0	.04000	22.0	.04545
20	29.4	.03401	27.0	.03703	27.7	.03610	24.1	.04166
21	33.1	.03021	29.8	.03355	30.7	.03246	26.3	.03802
22	37.0	.02702	33.5	.02985	34.1	.02941	29.5	.03389
23	41.4	.02415	36.9	.02710	37.5	.02673	32.1	.03115
24	46.5	.02150	40.6	.02463	41.4	.02415	34.9	.02865
25	52.0	.01923	44.6	.02242	45.6	.02192	37.8	.02645
26	58.4	.01712	49.0	.02040	50.0	.02000	40.9	.02444
27	65.3	.01533	53.4	.01872	54.9	.01821	44.0	.02272
28	73.5	.01360	58.4	.01712	60.2	.01663	47.3	.02114
29	81.9	.01221	63.2	.01582	65.3	.01531	50.5	.01980
30	92.5	.01081	68.9	.01451	71.4	.01400	54.0	.01851
31	103	.009708	74.6	.01340	77.5	.01290	57.4	.01742
32	114	.008771	80.0	.01250	83.3	.01200	60.6	.01650
33	129	.007751	86.2	.01160	90.0	.01111	64.1	.01560
34	144	.006944	92.5	.01081	97.0	.01030	67.5	.01481
35	161	.006211	99.9	.01001	104	.009615	70.9	.01410
36	181	.005524	111	.009009	111	.009009	76.9	.01300

Numerical Example

$$N = \frac{(20)(11.5) + \sqrt{(400)(11.5)^2 + (18)(1.000 + .0606)^2 (16.5)^2 (11.5)}}{(1.000 + .0606)^2 (16.5)}$$

$$N = 31 \text{ turns, length of coil} = \frac{N}{A} = \frac{31}{16.5} = 1.88''$$

For the coil whose value of length (l) lies between .4 and .1 of its mean diameter, the constants of equation (2) are changed slightly to give (3).

$$N = \frac{22L + \sqrt{484L^2 + 16(D+d)^2 A^2 L}}{(D+d)^2 A} \dots\dots\dots (3)$$

Equation (3) will give an error less than 5%.

Broadcast Transmitter Installation and Tuning

HAROLD E. ENNES

Station WIRE

Practical data on setting up and adjusting high-power broadcast transmitters

SINCE modern broadcast transmitters up to even 50 kw are largely self-contained, the installation problems are comparatively simple in comparison with the old days of filament machines and motor-generator sets. After the necessary ground screen has been installed under the site of the transmitter building, and the building itself completed to the point of constructing the floors, conduits for the necessary power and audio circuits should be installed before these concrete floors are poured. An idea of how conduit size may be estimated is given in Table 1, showing the careful planning necessary to determine the number and size of wires necessary for a given installation.

The size of wires necessary for the various circuits involved and amount of such wiring must be approximately determined before installation actually begins. Under practical conditions, for transmitter installation the most important consideration in determining wire size is the safe current-capacity rating. The temperature of a conductor increases as current flows through it, and the temperature rise determines the maximum safe carrying capacity of the conductor. Higher temperatures will cause deterioration and eventual destruction of the insulation. For example, it has been found that no. 4 copper wire with rubber insulation will carry safely a continuous load of 70 amps. The same size wire using tape or cambric insulation will safely carry 90 amperes continuously.

When commercial transmitters are to be installed, the manufacturer furnishes a chart of recommended wire sizes and approximate total length of each wire size needed for a typical installation. Table 2 shows a sample of this kind of chart and wire installation instructions. When a used transmitter is to be in-

stalled and these original instructions no longer exist, or where composite equipment is to be used, the current demands of the various circuits must be determined and appropriate wire-data tables used. The carrying-capacity values are taken from the National Electrical Code, and care should be taken that all wiring is installed in accordance with the Underwriters specifications. Fig. 1 shows the filament rheostat wiring of an RCA 5-D using no. 2 V.C.C.L. single conductor wire to carry 90 amps of current. Fig. 2 illustrates one method of running lead-covered

wire to the proper numbers on the terminal block of the power control panel.

In general, it may be stated that all audio-frequency lines should be installed using twisted leaded wire, and grounding wires for this audio equipment should be separate from power apparatus and r-f grounds. If these precautions are not taken, trouble is apt to occur with background noise in the audio circuits due to voltage drop along the common ground wires carrying power and r-f ground currents. The audio equipment, including line terminations, pads, equalizers, line amplifiers and measuring equipment is placed in a separate rack apart from the transmitter itself, with power supply and audio circuit wiring run in conduits or raceways sunk in the floor and terminated at the base of the equipment.

TABLE 1

CONDUIT SIZES FOR DIFFERENT SIZES OF CONDUCTOR FROM NATIONAL ELECTRICAL CODE

Size of Conductor	Number of Wires in One Conduit or Tubing								
	1	2	3	4	5	6	7	8	9
	Minimum Size of Conduit in Inches								
18	1/2	1/2	1/2	1/2	1/2	1/2	1/2	1/2	3/4
16	1/2	1/2	1/2	1/2	1/2	1/2	1/2	3/4	3/4
14	1/2	1/2	1/2	1/2	1/2	1/2	1/2	1	1
12	1/2	1/2	1/2	1/2	1/2	1/2	1/2	1	1 1/4
10	1/2	1/2	1/2	1/2	1/2	1/2	1/2	1 1/4	1 1/4
8	1/2	1/2	1	1	1 1/4	1 1/4	1 1/4	1 1/4	1 1/4
6	1/2	1	1 1/4	1 1/4	1 1/2	1 1/2	2	2	2
5	1/2	1 1/4	1 1/4	1 1/4	1 1/2	2	2	2	2
4	1/2	1 1/4	1 1/4	1 1/2	2	2	2	2	2 1/2
3	3/4	1 1/4	1 1/4	1 1/2	2	2	2	2 1/2	2 1/2
2	3/4	1 1/4	1 1/4	1 1/2	2	2	2	2 1/2	2 1/2
1	3/4	1 1/2	1 1/2	2	2	2 1/2	2 1/2	3	3
0	1	1 1/2	2	2	2 1/2	2 1/2	3	3	3
00	1	2	2	2 1/2	2 1/2	3	3	3 1/2	3 1/2
000	1	2	2	2 1/2	3	3	3	3 1/2	3 1/2
0000	1 1/4	2	2	2 1/2	3	3	3 1/2	3 1/2	4
250000	1 1/4	2 1/2	2 1/2	3	3	3 1/2	4	4	4 1/2
300000	1 1/4	2 1/2	2 1/2	3	3 1/2	3 1/2	4	4 1/2	4 1/2
350000	1 1/4	2 1/2	3	3 1/2	3 1/2	4	4 1/2	4 1/2	5
400000	1 1/4	3	3	3 1/2	4	4	4 1/2	5	5
450000	1 1/4	3	3	3 1/2	4	4 1/2	4 1/2	5	6
500000	1 1/2	3	3	3 1/2	4	4 1/2	5	5	6
550000	1 1/2	3	3 1/2	4	4 1/2	5	5	6	6
600000	2	3	3 1/2	4	4 1/2	5	6	6	6
650000	2	3 1/2	3 1/2	4	5	5	6	6	6
700000	2	3 1/2	3 1/2	4 1/2	5	5	6	6	6
750000	2	3 1/2	3 1/2	4 1/2	5	6	6	6	6
800000	2	3 1/2	4	4 1/2	5	6	6	6	6
850000	2	3 1/2	4	4 1/2	5	6	6	6	6
900000	2	3 1/2	4	4 1/2	5	6	6	6	6
950000	2	4	4	5	6	6	6	6	6
1000000	2	4	4	5	6	6	6	6	6
1250000	2 1/2	4 1/2	4 1/2	6	6	6	6	6	6
1500000	2 1/2	4 1/2	5	6	6	6	6	6	6
1750000	3	5	5	6	6	6	6	6	6
2000000	3	5	6	6	6	6	6	6	6

Power Requirements

It is always advisable to have considered in the original choice of a transmitter site the availability of a-c power lines of a distribution voltage that is high enough to satisfy regulation requirements of the installation. Since

$$\text{Regulation} = \frac{\text{voltage drop}}{\text{voltage}} \text{ in per cent}$$

it is obvious that the higher the original distribution voltage the better will be the regulation. Where the distribution voltage (the voltage before being dropped down to 230 or 110 volts by the pole transformer) is too low to give good regulation characteristics, or where extremely variable loads are encountered from the feeders used, automatic current and voltage regulating devices are provided by the local power companies when such a need is shown.

For high-power installations, rectifier plate transformer, filter chokes and capacitors, and (where used) voltage-

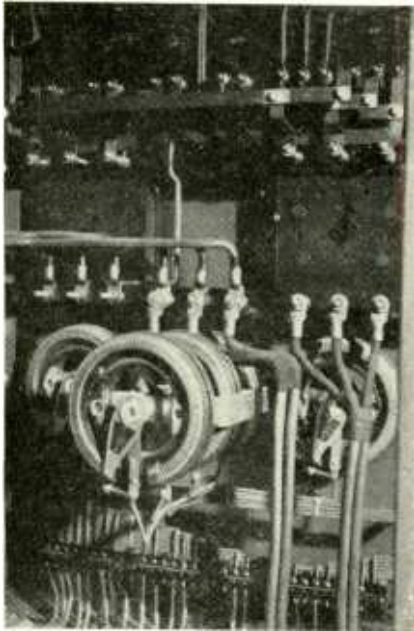

Fig. 1. Filament rheostat wiring of RCA 5-D. The leads carry 90 amps

temperature. Actually transformers may carry a load considerably more than their rating when such overloads are over short periods of time. This fact is important when considering loading practices of broadcast transmitters where power requirements vary with modulation of the transmitter. It is preferable to use self-supporting copper bus run through air for high voltage connections.

Modern transmitters are shipped in sections with most components already in place in the various units. These are usually the exciter unit, which may be a complete 100/250 watt transmitter in itself, the modulator unit, the intermediate or final 5 kw r-f amplifier, then the final 50 kw unit. With 50 kw transmitters, the final and modulator power supplies require separate units for the rectifier system, whereas with powers up to 5 kw each unit generally includes the rectifier system for that unit. Terminal boards with numbered connectors are used for inter-unit connections, and the wires run in raceways behind the transmitter or under channel provided in most modern transmitter racks in the elevated back base of the units. Manufacturers furnish detailed blueprints showing wire connections to each number on each unit, with appropriate wire size recommended. Parts which are to be mounted in each unit are numbered and their respective connections clearly indicated by photographs and schematic diagrams.

Cooling Systems

Most modern transmitters, even up to 50 kw rating, are now being installed with forced-air type cooling of power and modulator tubes. The method of mounting these tubes is greatly simpli-

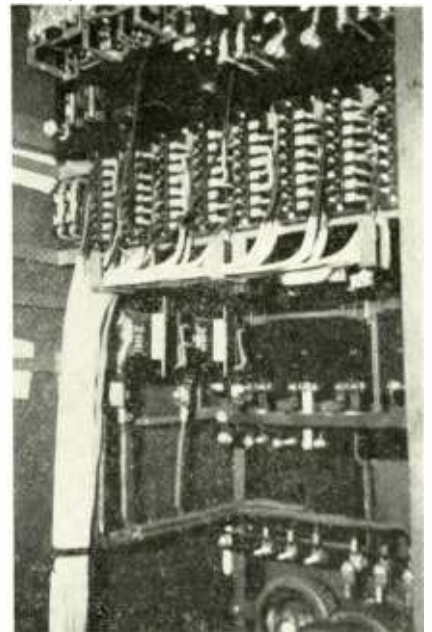

Fig. 2. One method of running lead-covered wire leads to power control panel terminals

regulating equipment are set up in a separate section of the room or in the basement when one exists. The high-voltage transformer may be set up in a special fenced-in area on the outside of the building to conserve building space. When used inside the building, the transformer is usually of the oil-filled type. In some states the Fire Insurance Underwriters require that these transformers be completely enclosed in a fire-proof vault. Other states require that only a low oil-proof sill be built around such equipment.

The capacity of a transformer is given in kilovolt amperes, and based on the load that it will carry continuously without having a temperature rise to exceed 55°C above a 30°C average ambient

fied insofar as installation is concerned over water-cooler types, because the tube with its attached fins is simply set in a hollow porcelain mounting. No clamping device is necessary and the anode connection is on the chrome-plated rim at the top of the porcelain mounting which forms the seat for the anode. The electrical connections are then made to the grid and filament. Just below the mounting are the air blowers and canvas ducts which force the air through the large surface exposed by the copper fins, and out through the top of the transmitter. Blowers are equipped with dust filters to prevent the deposit of dust particles on tube and transmitter components.

Where a water-cooling system is used,

DESCRIPTION							PANELS											WIRE DESIGNATION		
CONDUIT	FROM	TO	CIRCUIT	VOLTAGE	AMPERES	WIRE DESIGNATION PT. NO.	EXCITER	EXCITER TERM. BLOCK A	EXCITER TERM. BLOCK B	EXCITER TERM. BLOCK B-B	5 KW. AMPLIFIER	5 KW. TERM. BLOCK D	5 KW. TERM. BLOCK C	MODULATOR RECTIFIER	MODULATOR RECTIFIER TERM. B.L.F.	TERM. BLOCK E	CONTROL PANEL CP-34-100	CONTROL PANEL CP-131	PART NO.	SIZE OF WIRE
	162	1L1	RF			2					1W1								1	1/4" Dia. Copper Tubing
	162	1L1	RF			2					1W2								2	.125" Tinned Copper Bus
C-1	323	7S27	C	115	0.5	3	Ex 1											CPB2	3	No. 14 VCCL 600 V. Single Conductor
C-1	335	3R31	HV	1500	0.10	4	3				3W6								4	No. 14 VCCL 3000 V. Single Conductor
C-1	335	2T13	HV	1500	0.20	4	3								2W3				5	No. 14 VCCL 600 V. 2-Conductor
B	149		FM			8	AB													ETC.
C-1	169	7S8	M			3	9												7	
C-1	169	7R8	M			3	10												8	
C-1	344	3R12	HV	250	.02	3	11												9	

TABLE 2. Chart of recommended wire sizes and amounts required for a typical installation



Fig. 3. Showing method of handling elbows in concentric lines to allow for contraction and expansion

extraordinary precautions are necessary when installing a tube in the water jacket. The metal parts of the jacket which are movable should be coated with a light film of oil to help prevent corrosion. The tube is placed gently in the jacket, then, after being correctly seated, the retaining studs or jacket clamping device may be firmly fastened into place in such a way as to force the flange of the plate into solid contact with the water-tight gasket. The electrical connections are then made. These wires should not be near or should not touch the glass bulb, since puncture of the glass from corona discharge is apt to occur.

Transmission Lines

The energy to be transferred from the transmitter to the antenna is carried by coaxial or two to four wire lines. Although the concentric line is more expensive, it has proved to give superior performance over a long period of time. This line may be buried or mounted just above the earth's surface, and is usually made gas-tight and maintained under a pressure of dry nitrogen by means of a tank and regulating valve to prevent the formation of moisture within the line through "breathing". When the line is considerably larger than the rated carrier power demands of the particular installation, this feature may not be necessary.

The most important installation problems with concentric lines are obtaining air-tight joints and providing a way of handling contraction and expansion of the line with varying temperatures. Fig. 3 shows a simple method used at elbows of the line to provide for expan-

sion and contraction. This line is run from the top of the transmitter inside the building and brought out supported on iron posts as shown, then run down to within about a foot of the ground. Supporting iron posts are then used every 15 feet to the towers.

Preliminary Tuning

Before initial tuning procedure is attempted on a completed installation, it is well to double-check all wiring, power-control circuits and circuit breakers, and see that line fuses are of the correct current rating for the installation. It is especially important to see that ball gaps on power transformers and modulation reactors are adjusted to the recommended spacing. Tank circuit thermocouples should be disconnected on initial tuning adjustments to prevent damage from any possible cause such as self-oscillation or parasites. Some engineers prefer to use meters of much lower sensitivity in initial tuning than those used after tuning is roughly completed. Time delay relays should be adjusted to operate at approximately 30 seconds, and mercury-vapor rectifier tubes should have filament voltages applied 30 minutes before plate potentials are applied, to prevent arc-backs. Crystal heater circuits should be checked and allowed to heat the minimum length of time as per manufacturers instructions.

The plate caps of all tubes should be removed and line-voltage regulated by the auto-transformer or voltage regula-

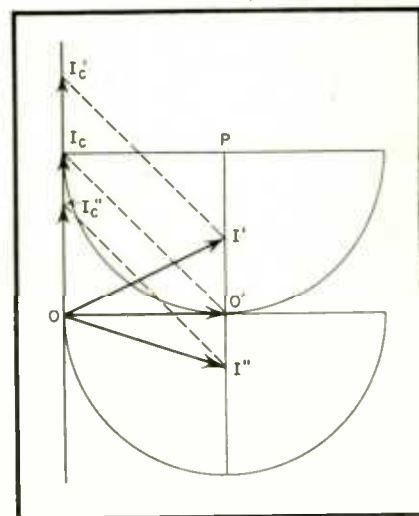

Fig. 4. Vector diagram shows that unity power factor and minimum current are obtained with the same capacitor adjustment, when capacity is the variable factor.

tor motor and filament voltages of each tube checked by a meter to ascertain that the voltages are within 2% of rated value. The oscillators may then be checked for proper operation by replacing the plate caps for that stage and closing the filament and plate switches on the exciter unit. Usually the r-f pickup to the frequency monitor is taken from the buffer or intermediate stage but the oscillator plate voltage and current should be checked to assure that they are functioning properly. Plate

[Continued on page 62]

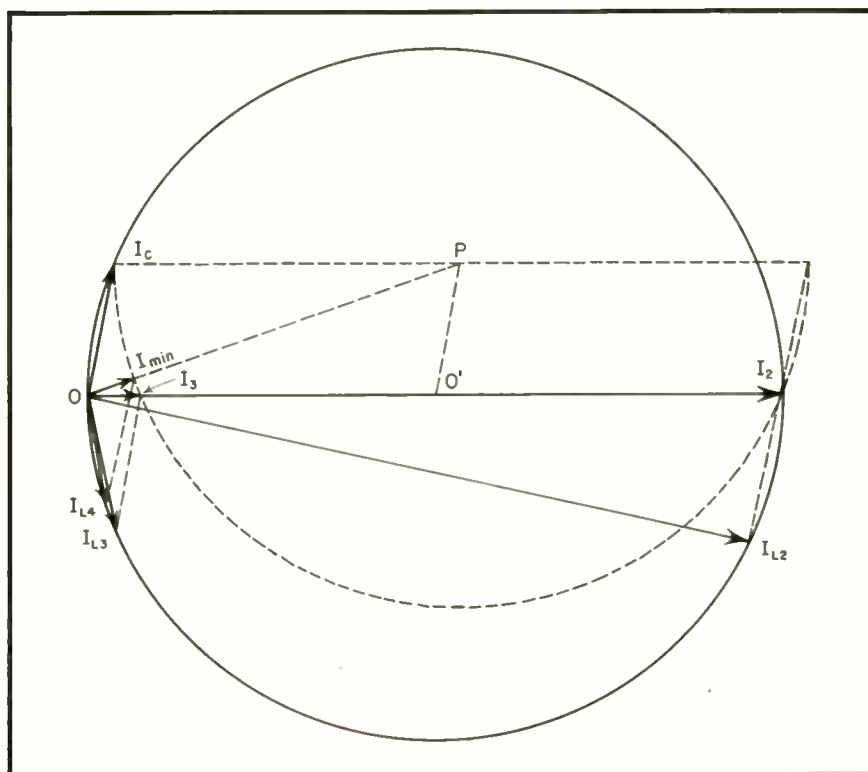

Fig. 5. Vector diagram for variable inductance tuning

Measurement of Receiver Characteristics

A. C. MATTHEWS

A thorough analysis of methods and technique used in laboratory tests of broadcast receivers

PART 3

ALTHOUGH the individual stage characteristics have been found satisfactory by measurements made as described in Part 2,* there is a good possibility that the overall receiver characteristics will not meet with approval. For example, the sensitivity and selectivity calculated from the single-stage data will often not agree with the overall measurements. AVC action may seriously impair the performance by introducing distortion with large signals, the signal-to-noise ratio may prove objectionable, or spurious responses may be troublesome. Needless to say, these shortcomings may appear particularly offensive if the measurement technique is faulty, in which case the measurements are of little value. As each performance test is described an effort will be made to point out possible sources of error.

Sensitivity

Overall sensitivity should be measured at three and preferably five test frequencies spaced throughout each wave band. The generator is modulated 30% with 400 cycles for either AM or FM. In the case of FM, 100% modulation is taken as plus and minus 75 kc deviation, therefore 30% modulation is equivalent to plus and minus 22.5 kc. Unless otherwise stated these values will be assumed.

The signal input is applied to the receiver through a standard or special

* RADIO, Dec. 1944

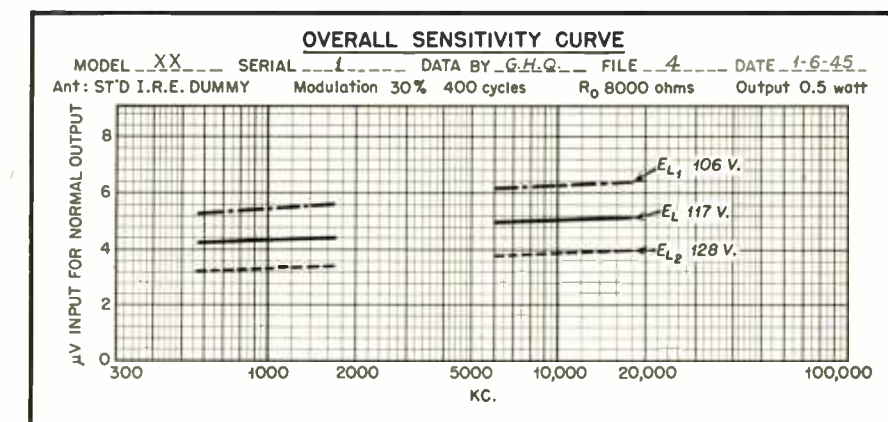

Fig. 22. Typical chart showing overall sensitivity curves of a receiver

dummy antenna that stimulates the antenna for which the receiver was designed, except for receivers using loop antenna where the signal is radiated from a coaxial loop. Both methods were described in Part 2 for single-stage measurements and need not be repeated at this time.

The power input voltage, with the receiver operating, should be adjusted to the normal value as given in Table 1 of Part 1.** The receiver (at maximum sensitivity) is then carefully tuned to the desired test frequency, using a reasonably small input. An appreciable error will sometimes result if a strong signal is used, because the AVC system may cause a slight detuning effect. For this reason adjustments should be

** RADIO, Nov. 1944

made with a minimum of signal input thus avoiding possible overloading or detuning effects.

Sensitivity is measured in microvolts when a standard dummy antenna is used and in microvolts per meter when the receiver employs a loop antenna. It is defined as "the least signal input voltage of a specified carrier frequency, modulated 30 per cent at 400 cycles, which results in normal test output when all controls are adjusted for greatest sensitivity". (IRE Standards Definition)

The sensitivity curve is plotted with test frequencies as abscissas on either a linear or logarithmic scale and with input in microvolts as ordinates on a linear scale. If the receiver has more than one waveband it is customary to use a logarithmic scale and include all data on one graph as shown in Fig. 22. Curves

at the upper and lower limits of power input voltage are measured in the same manner.

Unusual discontinuities in the sensitivity curve often caused by improper bypassing or ground connections should be investigated. It is important that the low potential side of the signal generator be connected to the low potential receiver input terminal and not to any convenient point on the chassis. This is particularly true at high frequencies, where ground returns are especially important. The connecting cable or leads, and the dummy antenna should be placed well away from parts of the receiver which might cause feedback.

Receivers with high sensitivities often have an appreciable amount of back ground noise along with the desired signal; it is therefore necessary to make allowances for this when measurements are made. A sharply tuned 400-cycle band-pass filter can be connected between the receiver output and the output meter which will often suppress the noise to such an extent that it becomes negligible, but the attenuation of the

filter at 400 cycles must obviously be taken into account in determining the true sensitivity. If the noise level is still appreciable an incremental reading of the output meter is necessary. When a power-type meter is used, the incremental output power is equal to the observed total power minus the observed noise power (zero modulation). If a voltmeter type output meter is used the desired voltage is calculated by equation 3.

$$E_o = \sqrt{E_t^2 - E_n^2} \quad (3)$$

where E_o equals voltage required for normal output, E_t equals total output (noise plus signal) and E_n equals noise only (zero modulation).

Many engineers are interested in knowing the input in microvolts necessary to produce full output from the receiver. This is measured in the same manner as normal sensitivity, except in determining the input necessary to produce normal output the input is increased until full output (10% distortion point) is reached. This is known as the overload sensitivity and will be used later to evaluate the microphonic

tendencies of the receiver. A maximum-output sensitivity is also measured with 80% modulation.

The overall sensitivity can now be compared to previous measurements. For instance, the first detector or converter grid sensitivity times the r-f and antenna stage gains would normally be expected to compare favorably with the measured overall sensitivity. However, as mentioned in the section on converter measurements, this is not always true because the converter grid sensitivity, measured across the converter grid circuit, does not simulate actual operation. The presence of the generator therefore probably disturbs some coupling condition existing between the local oscillator and the converter grid thereby changing the converter transconductance.

This is only one reason why the sensitivities do not always check. Regeneration or degeneration might also be the cause and can be checked by comparing selectivity measurements. Calculation of the image response from the r-f selectivity curve as compared with the overall measurement of the same will also indicate whether an appreciable amount of regeneration or degeneration is present.

Fig. 23. Overall selectivity is plotted on this type of chart

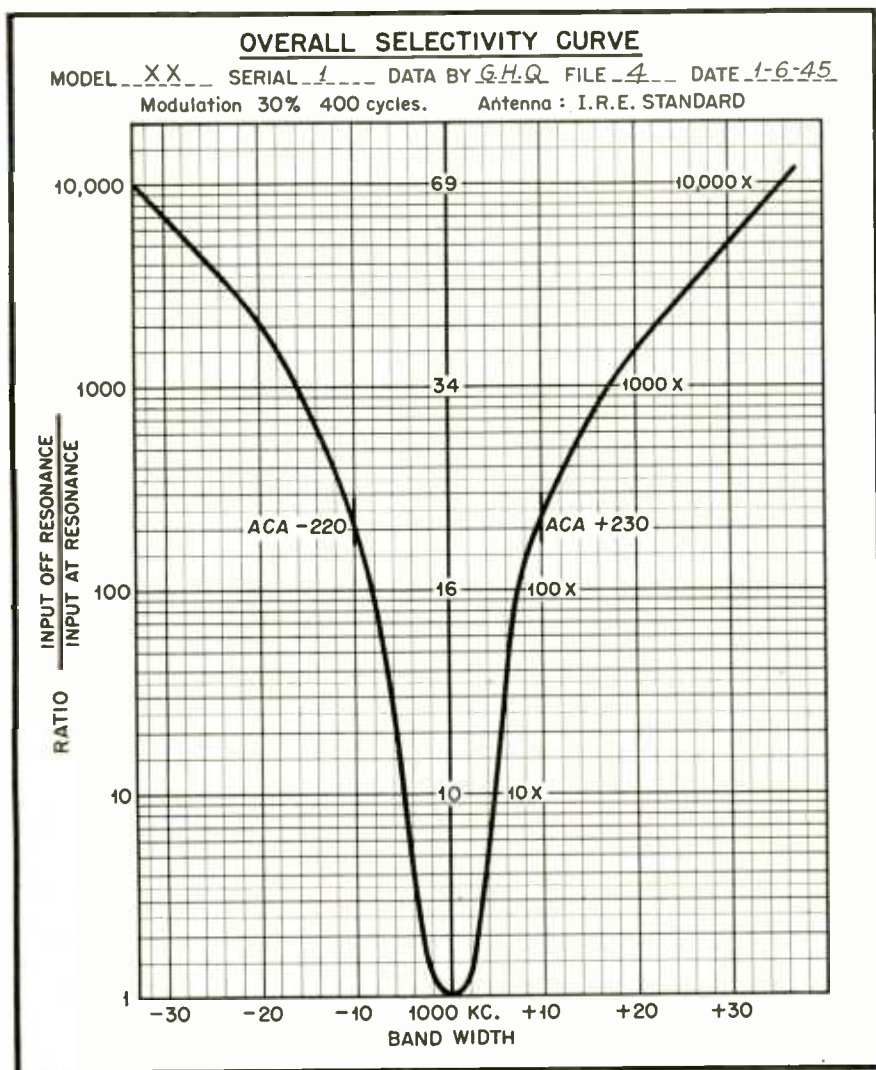

Selectivity

Selectivity is usually measured at approximately the mid-point of each band by first adjusting the receiver to give normal output when tuned to the test frequency as in the sensitivity test. The same precautions as to grounds should be observed when making selectivity tests as outlined for sensitivity measurements. The signal generator is then detuned on each side of the test frequency, increasing the signal input to maintain normal output from the receiver, until a point 100 kc off resonance is reached. The signal input exceeds one volt, or the input has been increased 10,000 times that required for the sensitivity measurement. Readings are taken at inputs of 2, 5, 10, 100, 1000 and 10,000 times normal.

If none of these points corresponds to ± 10 kc from resonance, this value should also be measured (in the broadcast band) since this is a measure of the adjacent channel attenuation. ACA. The ACA should be approximately equal on each side of resonance if the single stage selectivity curves are symmetrical. Should this not be the case it is well to investigate the cause. One likely source of trouble with loop receivers is magnetic coupling between the loop and an i-f, or even r-f, stage. This simple expedient of reversing the loop antenna will sometimes correct this, although it may introduce some other equally bad effect. Should revers-

ing the loop antenna be found desirable it would be wise to repeat all measurements made thus far in order to make sure no other changes have taken place.

Another cause for unsymmetrical curves, as mentioned previously, is caused by an appreciable amount of frequency modulation present in the r-f signal generator. This is especially true when measuring highly selective receivers because, as the signal generator is detuned from resonance during the selectivity measurement, any change in impressed frequency will result in a change in voltage at the detector, due to the slope of the selectivity curve. The detector is therefore not able to differentiate between frequency modulation of the signal generator or a change in amplitude modulation. Thus, with frequency modulation present, it will appear as an additional amplitude modulation on one side of the selectivity curve thereby resulting in an unsymmetrical curve. Likewise, if the true curve is unsymmetrical this effect can produce symmetry. The use of an unmodulated signal generator with means for indicating carrier strength, such as a microammeter in series with the diode load, will eliminate this effect. Most measurements, however, require that the audio section of the receiver be in operation, so this method is somewhat limited in application.

Selectivity can be plotted in terms of selectance or bandwidth. The latter is preferred because it shows us the shape of the curve near resonance where an excess of selectivity will affect the overall fidelity due to attenuation of the high modulating frequencies. Selectivity data is plotted on semi-log paper, with frequency as abscissas on a uniformly divided scale, and the ratio of input off resonance to the input at resonance on a logarithmic scale as ordinates, as shown in Fig. 23.

Measurements with a single signal generator do not give us a complete picture of receiver performance in the presence of interfering signals. For this reason a two-signal generator test is made. Connections are shown in Fig. 24. One generator represents the desired signal and the other, the undesired or interfering signal. The desired signal modulated 30% at 400 cycles is set at a standard input ($50 \mu v$ — distant, $5000 \mu v$ — mean, $100,000 \mu v$ — local, 1 or 2 volts — strong signal) and the receiver tuned and adjusted to give normal output. The modulation is now reduced to zero while the second generator (interfering signal) modulated 30% at 400 cycles is applied at successively one, two, three, etc., channels off resonance. At each point the input from the second generator is adjusted until the receiver output is 30 db below nor-

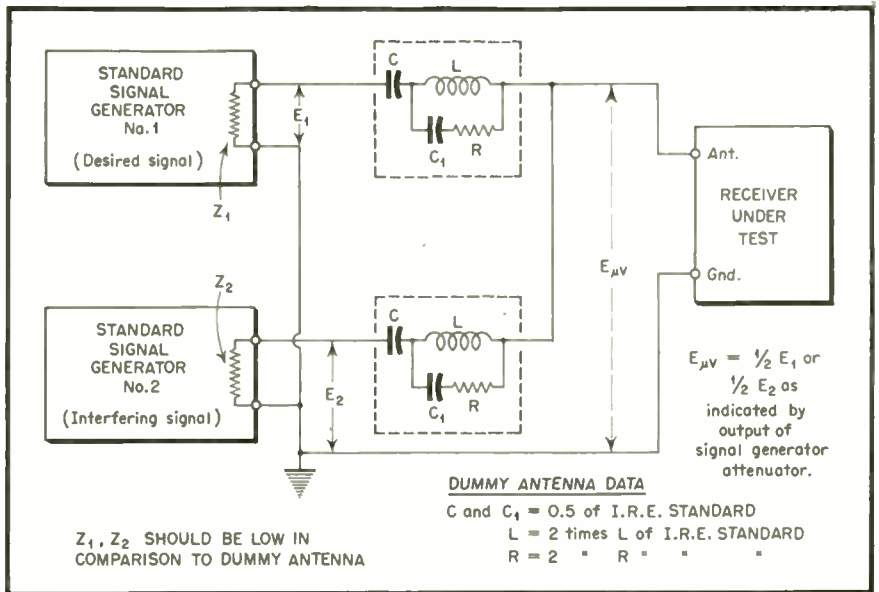

Fig. 24. Connections for two-signal tests of a radio receiver

mal, which in the case of normal output is 0.5 milliwatts.

Cross-modulation and masking effects can also be checked by using two signal generators but since little trouble is experienced from these phenomena in a modern receiver they will not be discussed at this time.⁹

Fidelity

The overall-electric fidelity (hereafter called fidelity to distinguish it from sound pressure fidelity, which is a measure of acoustic output) shows the overall audio frequency characteristics of the receiver. This test is made at approximately the mid-frequency of the r-f band unless the selectivity of the receiver varies considerably from one end of the band to the other, in which case curves are taken at each end. Fig. 25 shows curves of a representative receiver wherein the selectivity has

caused severe attenuation of the high audio modulating frequencies. With a mean-signal input ($5000 \mu v$) modulated 30% at 400 cycles, the receiver is tuned to resonance and the volume control set to give normal output. This is our reference point for the entire curve and therefore must be carefully checked; hum or noise, if present, must be accounted for in the results. The modulation frequency is then varied from 30 to 10,000 cycles, keeping the per cent modulation constant while the output voltage is recorded. Fidelity curves should be made with the tone controls also adjusted to their extremes, and if the volume control is part of a compensation network, an additional curve should be taken at the point of maximum compensation. Care should be taken to prevent overloading the receiver if abnormal peaks are encountered. When this occurs the input should

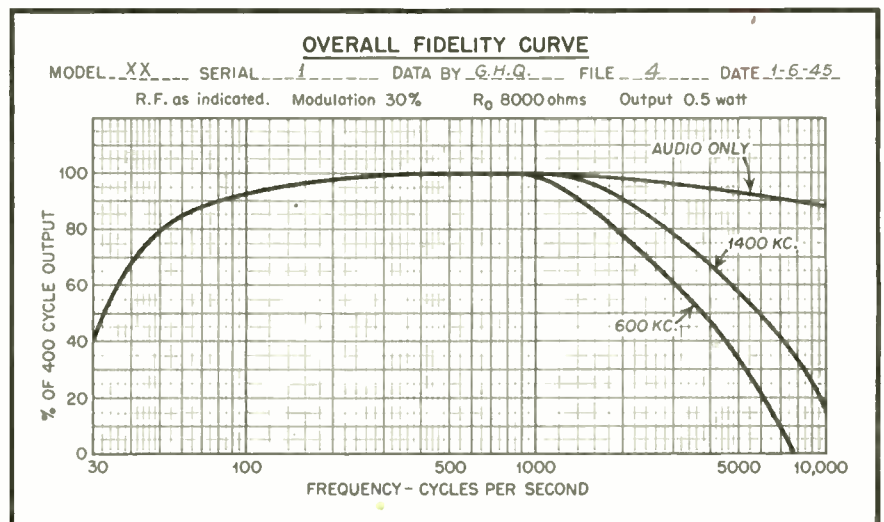

Fig. 25. Method of plotting overall fidelity curves

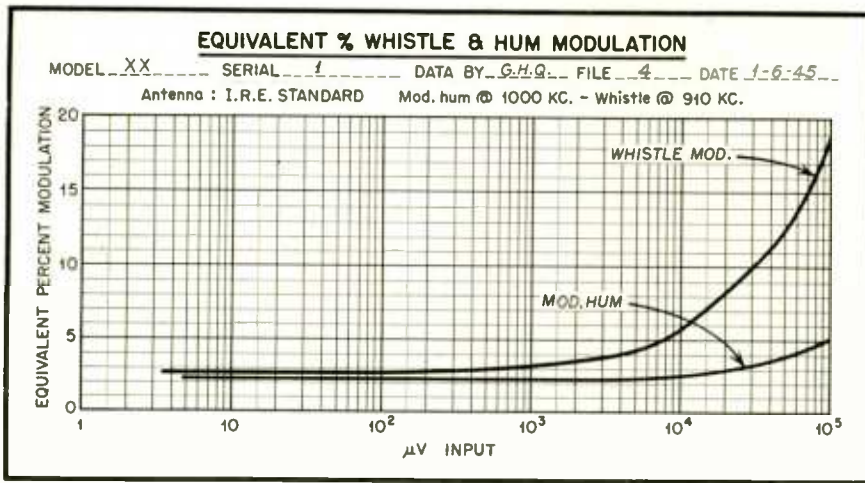

Fig. 26. Curves showing equivalent per cent whistle and hum modulation

lator is higher or lower in frequency. For example, if the oscillator is above the desired signal, then the image will be above and vice versa. Image response is expressed as a ratio of the input in microvolts modulated 30% at 400 cycles required to give normal output at the test frequency, to the input required at the image frequency to produce the same output. The receiver remains tuned at the first or test frequency during both measurements.

Another spurious response, of lesser importance than the first two mentioned because it only occurs at harmonics of the intermediate frequency, is known as the Harmonic Tweet or Whistle. Ordinarily only the second harmonic is objectionable although higher order harmonics are sometimes observed. Any feedback from the second detector or i-f amplifier is likely to exaggerate the effect and therefore care should be taken to keep all leads well away from this portion of the receiver.

The measurement is known as Equivalent Whistle Modulation and is checked as follows. The signal generator with zero modulation is adjusted to approximately twice the intermediate frequency and the receiver with speaker connected is tuned to produce a whistle of maximum intensity to the ear. The receiver is tuned rather than the signal generator since this more nearly represents actual operating conditions. Modulation is then applied (30% at 400 cycles) and the volume control adjusted slightly below maximum undistorted output. The output voltage is recorded for the 30% modulated signal, after which the modulation is reduced to zero, and the whistle voltage measured with the same r-f input. This procedure is repeated at several inputs from 100 microvolts to one volt, the volume control being adjusted each time to prevent overloading. From this data equation 4 is used to compute the equivalent whistle modulation in percent.

$$m = 30E_w/E_s \quad (4)$$

where,

- m = whistle modulation in percent
- 30 = per cent signal modulation
- E_w = whistle output voltage
- E_s = signal output voltage, modulated 30% at 400 cycles.

A representative curve is shown in Fig. 26.

Other spurious responses caused by harmonics of the local oscillator beating with the fundamental or harmonics of an interfering signal are not often encountered although if they cause serious interference a measurement should be made of their sensitivity.

Equivalent-Noise-Sideband Input (ENSI)

The sensitivity of a receiver is limited by the amount of noise originating in

be reduced and the fidelity remeasured.

It is permissible to measure the output across the speaker voice coil instead of the output load, in which case the speaker should be mounted on a baffle or in its cabinet with the receiver in place. The curve data sheet should be plainly marked if this method of measurement is used.

Overall fidelity curves are plotted on semi-log graph paper with the audio modulating frequencies as abscissas on a logarithmic scale and the relative receiver output as ordinates on a linear scale. For comparison, the characteristic of the audio section of the receiver alone is sometimes plotted on the same graph. This shows the amount of attenuation due to tuned circuit selectivity.

Sound pressure fidelity curves take into account the acoustic output of the speaker and are taken when the necessary equipment is available, however unless one has had considerable experience in interpreting this type of curve the results are often misleading.

Spurious Responses

Probably the most serious spurious

response in a receiver is caused by pickup of signals at the intermediate frequency since this affects reception at all points in the tuning range. This is known as the Intermediate Frequency Response and is measured in microvolts ($\mu v/m$ for loop receivers) or, as a ratio of signal input at the i-f to the signal input at the desired frequency to give normal output. The receiver is tuned to one of the standard sensitivity test points while a signal at the intermediate frequency is applied through a dummy antenna or radiating loop. The i-f signal input is then adjusted to produce normal output. This is repeated at each of the sensitivity test points.

The second spurious response of importance is that caused by the local oscillator beating with an incoming signal whose frequency is twice the intermediate frequency from the desired signal. This is known as the Image Response. The image signal can be either higher or lower than the desired signal according to whether the oscil-

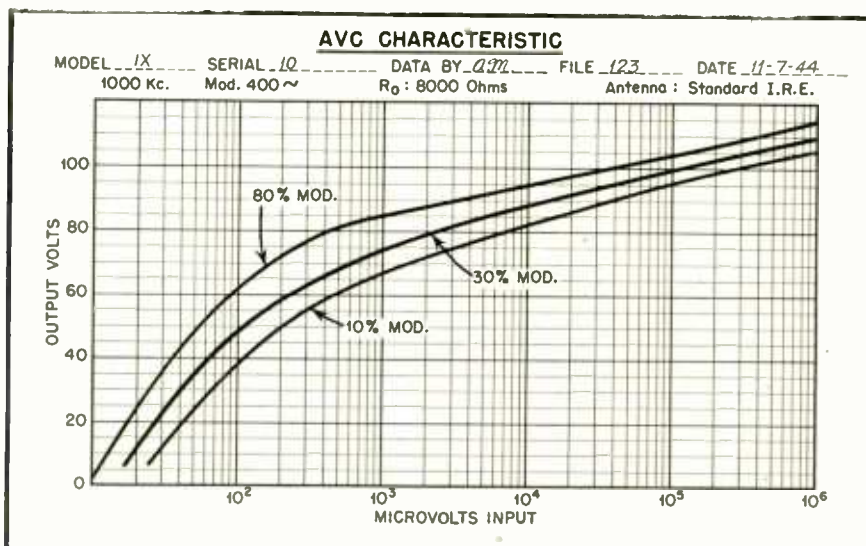

Fig. 27. Standard AVC characteristic curves for various modulation percentages

its circuits; it is therefore necessary to know this quantity before it is possible to evaluate the usable sensitivity. ENSI is defined as "the equivalent input magnitude of all random noise which is transferred to the output circuit"; in other words, the magnitude in microvolts of all noise within the frequency passband of the receiver. The following equation 5, is self-explanatory.

$$E = mE_s(E_n/E_s^1) \quad (5)$$

Where,

- E = ENSI in microvolts
- E_s = modulated signal input in microvolts
- m = signal modulation factor (0.3 for 30% mod)
- E_n = noise output voltage
- E_s^1 = signal output voltage.

Measurements are made at all standard sensitivity test points with the equipment connected the same as for sensitivity checks. A signal at the required test frequency, modulated 30% at 400 cycles, and adjusted to an amplitude of from three to ten times the computed noise voltage, is applied to the receiver. The volume control is then adjusted to give a reading below the overload point. With an r-m-s voltmeter, and using a 400-cycle filter, the signal output volts are measured. The filter is then removed and the total signal-plus-noise output volts recorded. Next the generator modulation is reduced to zero and the remaining output noise volts measured. The carrier input is maintained constant throughout these tests. In lieu of a 400-cycle filter the output signal voltage may be determined by correcting for noise as described previously for sensitivity tests.

ENSI is expressed in microvolts at a specified frequency and is usually tabulated along with sensitivity readings for each waveband.

HUM—Residual and Modulation

There are two sources of disturbing hum present in most receivers: (1) residual, (2) modulation hum.

Residual hum is measured across the output load with the receiver volume control set at minimum as outlined under audio frequency measurements in Part 2.

Modulation hum is measured with the receiver operating normally and the volume control adjusted to give approximately maximum undistorted output with a signal modulated 30% at 400 cycles. Tune controls should be set at maximum. Inputs at all standard values from 50 microvolts to 1 or 2 volts are applied to the receiver and the output voltage measured, first with modulation on and then off.

The equivalent percent modulation hum is then calculated from equation 6 and the results plotted as shown in Fig.

26. Unless the equivalent per cent hum modulation is at least three times the residual hum these measurements have little value.

$$m = 30E_n/E_s \quad (6)$$

Where,

- m = hum modulation in percent
- 30 = per cent signal modulation
- E_n = hum output voltage
- E_s = signal output voltage.

Automatic Volume Control

The measurement of automatic volume control characteristics is usually made with the receiver tuned to the center of the frequency band. The volume control is adjusted so that audio overload does not occur with an input of one volt when modulated 80% at 400 cycles. Receiver output is then measured as the input is varied from approximately one microvolt to one volt for modulation of 10, 30 and 80%. This data is plotted as shown in Fig. 27 with input in microvolts as abscissas on a logarithmic scale and output volts as ordinates on a linear scale.

AVC Distortion

The AVC distortion is measured in much the same manner as the AVC characteristic, except that percent audio distortion instead of output voltage is measured vs. input signal with 10, 30 and 80 per cent modulation. Two sets of curves are made, one with the volume control adjusted to approximately maximum distorted output and the other at approximately one-half output as shown in Fig. 28.

Microphonics

Microphonics are quite difficult to measure, but checks should be made to determine whether the receiver is rea-

sonably free from such effects. The receiver should be physically located in such a manner that acoustic feedback will not occur between the speaker and the signal generator used for the tests. Measurements are made at the same test frequencies used when overload sensitivity was measured.

The signal input to the receiver, without modulation, is increased until microphonics occur. Several checks are made at each point and the average value of the input in microvolts are microvolts per meter at which microphonics begin is considered the microphonic level. Notes should be made, if possible, as the source of the microphonism, such as tuning condenser, tubes, padding condensers, etc. Comparing this value with the overload sensitivity previously measured will give us the microphonic-overload ratio. Obviously, the higher the ratio the better the receiver as far as microphonism is concerned.

Power Output

Two curves are necessary to show the power output characteristics of a receiver: (1) power output vs. input, (2) power output vs. distortion.

The first curve shows the maximum power output without regard to harmonic distortion and is measured with the receiver at maximum sensitivity. An r-f signal with 400-cycle modulation is applied to the receiver input and its amplitude varied from 1 to 1,000,000 microvolts at 10, 30 and 80 per cent modulation, as the output voltage or power across the dummy load is measured. Compensation should be made for noise or hum if appreciable. The re-

[Continued on page 64]

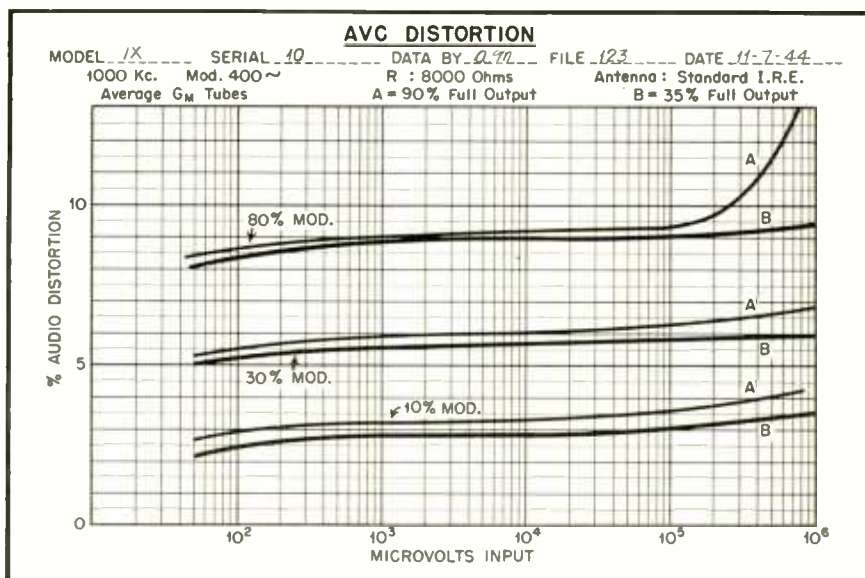

Fig. 28. Typical AVC distortion curves. Output voltage is measured vs. input signal of 10%, 30%, and 80% modulation. Output lever (A) is 90% of full output; (B) is the curve for 35% of full output

Difficulties in MULTIPHASE

MULTIPHASE filaments in transmitting tubes were introduced to the industry a few years ago as a result of the trend toward complete alternating-current operation of transmitting equipment. Three principal advantages were claimed for them: a balanced load on the power lines, a lower hum level, and lower filament transformer costs. The increase in the power of transmitters with the attendant increase in the size of tubes has added to the appeal of these arguments.

Experience with the operation of transmitting tubes employing multiphase filaments has revealed that one of these reasons is actually false and that there are disadvantages which far outweigh the remaining two. It is the purpose of this paper to present the results of investigation and operating experience on multiphase filament tubes.

Hum Modulation

The most important of the three advantages claimed for multiphase filament operation with the current emphasis on high-quality, low-noise-level transmission is that of reduction in the level of the hum modulation due to filament heating current. Such modulation is caused almost entirely by the magnetic field of the filament. Since this field increases with the magnitude of the filament current it would be expected to assume greater importance as the size of the tube increases.

It was for this reason that an investigation was carried out by one of the writers to determine the relative hum modulation due to filament excitation to be expected from different types of power tubes under various operating conditions. A series of measurements was made with the tubes in a self-excited oscillator operating on approximately 520 kc. The plate supply consisted of a three-phase full-wave recti-

Troubles arise in multiphase operation of transmitting tube filaments. This article describes these troubles and methods of overcoming them

fier with sufficient filter to give a plate voltage ripple 70 db below the rectified DC voltage output. Hum modulation of the carrier was measured with a General Radio Type 731-B modulation monitor using an external 50 μ a meter in series with the 600 μ a meter contained in the monitor. The instrument was calibrated for the new low range. Carrier modulation as low as 70 db below carrier can be read quite accurately by this method. The hum modulation

for each type of tube was measured over wide ranges of plate voltage, plate current, grid bias, and grid swing. In the case of multiphase filament tubes, measurements were made with single phase, three-phase, and six-phase filament excitation.

The data obtained show a good correlation between hum modulation and grid saturation. Examination of the data suggested that if a convenient measure of the degree of grid satura-

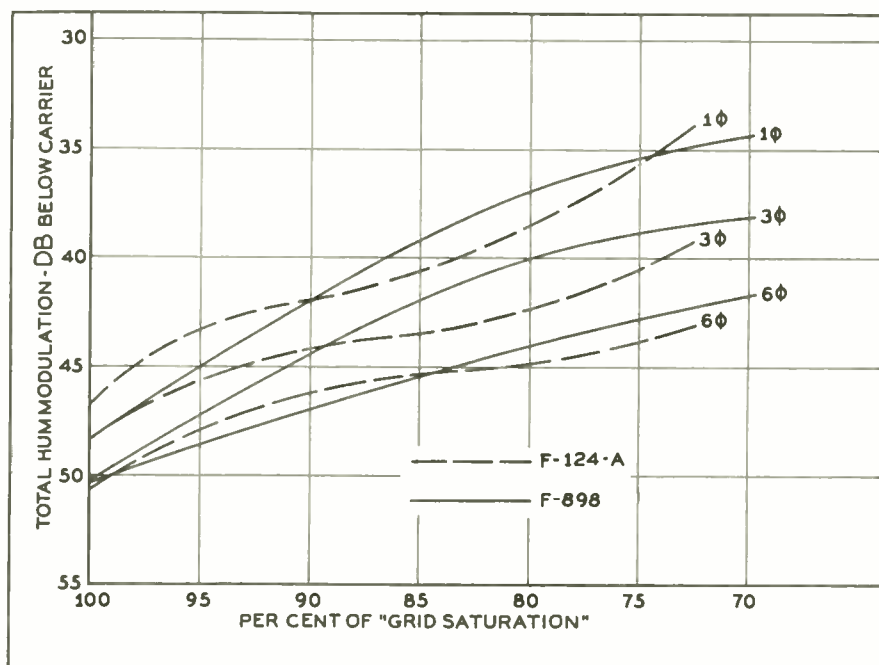

Fig. 1. Typical curves showing total hum modulation as a function of grid saturation

FILAMENT OPERATION

A. K. WING, Jr. and H. W. BAKER

Federal Telephone and Radio Corp

tion could be set up it would be possible from similar data for a given type of tube to predict the hum modulation due to filament excitation for any set of operating conditions.

The region of grid saturation may be defined as that portion of the tube characteristic in which with a constant load impedance a positive increment in grid voltage results in either no change or a decrease in plate current. This mode of operation produces a plate current pulse having a flat top or a dip at the crest. Inspection of constant current curves for various tube types shows that although the region of grid saturation varies somewhat, depending on the design characteristics of the tube type, it is always quite close to the diode line. Therefore, if we assume that the diode line represents the point of maximum grid saturation for any plate voltage and load impedance, we may say that the ratio of the length of the operating line under any given condition to the length of an operating line of the same load impedance extending to the diode line is a measure of the degree of grid saturation for that condition. While this assumption is only approximate it was found to give a reasonably satisfactory means of predicting hum modulation for any selected mode of operation.

Total hum modulation as measured under a wide range of operating conditions for each tube type under consideration was plotted against the degree of grid saturation. The results for multiphase-filament types F-898 and F-124-A are shown in the total hum modulation curves, Fig. 1. Inspection

of these curves indicates that with these two different types of multiphase filament structure, when operating in the region of grid saturation, the hum modulation is reduced by approximately 2.5 db by the use of three-phase rather than single-phase filament excitation. The type F-124-A will give an additional 2.5 db reduction in hum modulation when six-phase is substituted for three-phase filament excitation.

While this data does show some reduction in the measured hum modulation level by the use of multiphase filament excitation, the sensitivity of the human ear and the characteristics of the receiving equipment affect the ultimate result. Ear sensitivity is con-

cerned with the least intense sound that can be heard. Such a sound is said to be at the "threshold of hearing". The principal hum modulation frequencies caused by single-phase, three-phase, and six-phase filament excitation are normally 120, 360 and 720 cycles per second, respectively. Published data on the average human ear indicates the following "threshold of hearing" levels in terms of db above a reference level of 0 db at 800 cycles per second, corresponding to a level of 10^{-16} watts per square centimeter.

720 cycles per sec. 1 db
360 cycles per sec. 10 db
120 cycles per sec. 30 db

From this it is apparent that the hum level due to single-phase filament excitation can be 20 db higher than for three-phase, and 29 db higher than for six-phase, without being more audible to the human ear. Inasmuch as the greatest measured difference in hum level at 100% grid saturation is in the order of 5 db, the effective audible hum level is actually lower in the case of single-phase filament excitation. These results assume the use of perfect receiving equipment, capable of reproducing all frequencies equally. In actual practice the average receiver will respond to 360 or 720 cycle modulation much better than to 120 cycle with the result that the lower frequency is still further discriminated against.

Present-day operating practice can be counted upon to lessen still further the need for multiphase operation in so far as hum modulation is concerned. In many cases the quadrature connection of the filaments of two tubes each operated single-phase and used in parallel or push-pull will result in further reduction of the resulting hum modulation.

This precaution should be observed in cases where the plate load impedance is negligible for the hum frequencies as

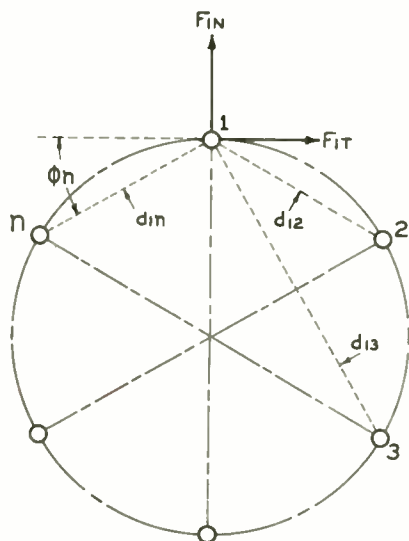

Fig. 2. Diagram of the forces acting upon a multiphase filament

would be the case for radio-frequency amplifiers. Where this condition is not met as in the case of push-pull audio applications, the filament voltages of the two tubes should be in phase since cancellation can then take place in the plate circuit. In class B audio applications this hum cancellation is realized under the conditions of zero signal where it is most important. On the basis of this data and considering that the present-day practice of using overall inverse feedback on fixed-frequency transmitters has further reduced the hum modulation, the type of filament excitation employed is no longer a determining factor in the final carrier hum modulation.

Magnetic Forces on Filaments

One of the limitations on the life of a transmitting tube filament and consequently on the life of the tube is its ability to withstand the forces to which it is subject. These forces are of three kinds: electrostatic, magnetic, and mechanical. Electrostatic forces are usually of important magnitude only in the case of high voltage thermionic rectifiers where the difference in potential between the filament and the anode is twenty thousand volts or more. In the case of the conventional triode, the grid-filament potential rarely exceeds a few thousand volts and as a consequence the electrostatic force on the filament strands is negligible. Forces between filament strands and filament sections due to the magnetic fields set up by the filament heating current can, however, very easily reach destructive magnitudes.

The magnitude of the total force in grams between two filament strands of length l centimeters, spaced d centimeters and carrying instantaneous current amplitudes i_1 and i_2 amperes, is given by the expression:

$$f = 2.04 i_1 i_2 \frac{l}{d} 10^{-5} \quad (1)$$

It is apparent from the above expression that for equal currents, strand forces increase as the square of the heating current amplitude. These forces may become of great importance in high-power-output, long-life tubes having high filament-input power. Such multi-strand filaments must be designed so that magnetic forces on the filament strands are sufficiently small in magnitude as to cause no appreciable deformation. This is accomplished, in general, by a symmetrical placement of the filament strands and electrical connections such that the net resultant force on any one strand due to the magnetic field of all other strands is essentially zero.

As an example, consider a filament consisting of an even number of

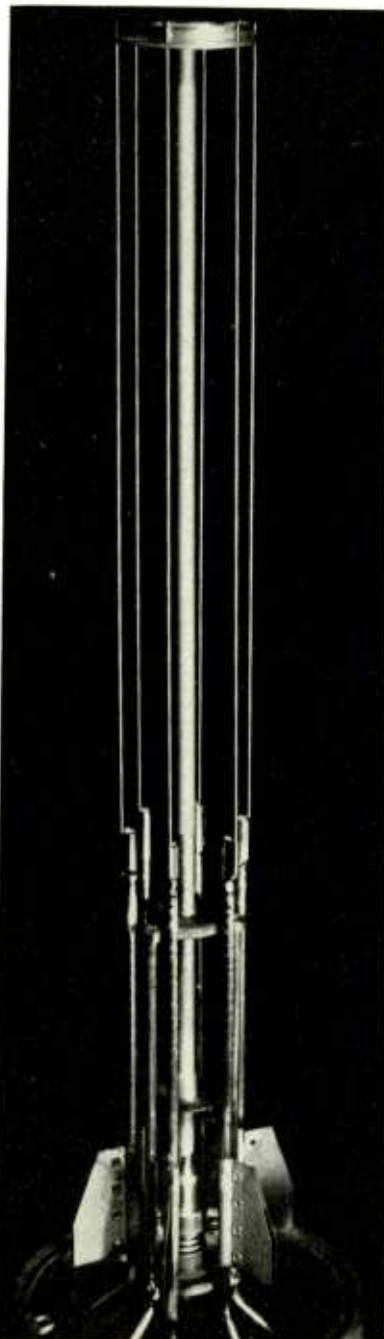

Fig. 3. Type F-893 filament mount showing typical single-strand construction

parallel filament strands equally spaced around the axis of the tube. Such an arrangement is shown diagrammatically in Fig. 2. For this configuration a simple expression for the tangential force F_{tn} in grams per centimeter length, on a given strand may be obtained.

$$F_{tn} = 2.04 \cdot 10^{-5} i_1 \left(\frac{i_2}{d_{12}} \cos \phi_{12} + \frac{i_3}{d_{13}} \sin \phi_{12} + \frac{i_3}{d_{13}} \sin \phi_{13} + \dots + \frac{i_n}{\phi_{1n}} \sin \phi_{1n} \right)$$

where d is the current in amperes in the investigated strand, and i_n is the current in the n th strand and d_{in} is the

distance in centimeters between strands l and n . ϕ_{in} is the space angle between a line through strands l and n and the tangent to the filament structure at strand l . From inspection of equation (2) it is apparent that for equal but opposite direct current in adjacent strands, the resulting tangential forces on all strands are equal and approach zero.

The expression for the outward normal force, F_n , on a strand is

$$F_n = 2.04 \cdot 10^{-5} i_1 \left(\frac{i_2}{d_{12}} \sin \phi_{12} + \frac{i_3}{d_{13}} \sin \phi_{13} + \dots + \frac{i_n}{\phi_{1n}} \sin \phi_{1n} \right)$$

Inspection of this equation and Fig. 2 indicates that the outward forces exerted under the same conditions as considered above are equal on all strands and negligibly small.

If, in the above expressions, we use effective values of alternating current, the resultant forces will be the same. Similarly, if we introduce the phase angles of the currents in the various strands we find that for symmetrical three- and six-phase filament structures where the phase sequence of strand currents progresses uniformly around the circumference, the tangential forces on the filament strands are in equilibrium and the normal force components are again equal and relatively small. We can conclude from this analysis that the type of filament structure considered is inherently mechanically stable for direct current, single-phase, three-phase and six-phase operation so long as the strand currents are of equal magnitude and the phase sequence uniform around the circumference. It becomes of utmost importance, therefore, to make the proper filament terminal connections for any type of filament heating power.

Mechanical Forces on Filaments

Mechanical forces may be set up in a filament for a variety of reasons. Uneven heating or cooling rates for different parts of the structure may result in forces being set up which will stress the filament strands beyond their elastic limit. Other causes will be apparent upon examination of typical structures.

There are in use two principal types of multiphase filaments. The first type, historically, is represented by the structure used in the types 893 and 898 tubes and is illustrated in Fig. 3. Six symmetrically-placed filament strands are fastened to a center support rod at one end. A compression spring acts through the center support rod to keep the filament strands under slight tension at all times. Great care must be taken in the assembly of this structure to assure equal tension and equal length

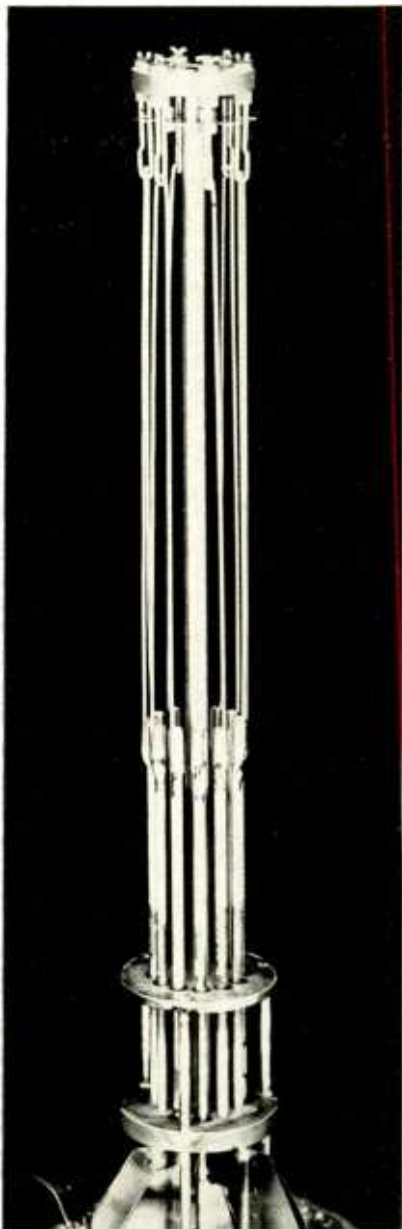

Fig. 4. Type F-124A filament mount, showing typical folded-strand construction

in all filament strands. The diameter of each strand must be very accurately matched, so that in operation the filament strands will reach the same operating temperature and hence will all expand an equal amount. Obviously, if one filament strand should expand a greater amount than the other strands, mechanical forces will be set up within the filament structure resulting in deformation of one or more strands.

So far only the manufacturing precautions necessary to minimize the mechanical forces with this type of filament structure have been discussed. Probably the most destructive forces to be encountered, however, are those resulting from unequal filament strand currents and improper phasing of the currents in the various strands. The

unequal strand currents will not only cause resultant magnetic forces which may be large, but will cause unequal strand expansion due to the difference in operating temperature. Since the strands are all fixed rigidly at both ends relative to one another, they are unable to expand independently. The resultant mechanical forces must, therefore, relieve themselves by deformation or breakage of one or more strands or by the shift of the entire filament structure from its vertical axis. Once a strand is deformed, the magnetic forces are no longer in equilibrium. In addition, subsequent heating and cooling cycles of the filament keep increasing the mechanical stress in the structure with the eventual result of a broken filament strand or a grid-filament short. Any tendency for filament strands to evaporate at unequal rates during life and hence to become unequal in diameter will aggravate this condition. It should be noted that the same situation exists for this particular structure for single-phase or even d-c excitation as for three- or six-phase.

The other principal type of multiphase filament, represented by the structure used in the Federal F-124-A tube was designed to overcome those difficulties and is illustrated in Fig. 4. Six symmetrically-placed folded strands are used. Inasmuch as the folded strands, or hairpins, are rigidly mounted at only one end of the structure and the closed end of the hairpin is simply guided by an elongated loop that is electrically insulated from the center support structure, each hairpin is free to expand independently of the others. This type of multiphase filament structure, while more expensive to build, has the outstanding advantage of completely eliminating the problem of mechanical forces set up within the structure due to unequal expansion of the individual elements.

Uniform phase progression cannot be attained for multiphase operation with this type of filament structure. A phase sequence can be chosen, however, such that the maximum stress on any strand is well within safe operating limits. Calculation of the deflection of the filament used in the F-124-A tube indicates a maximum tangential strand displacement of only 10^{-4} mm. As in the case of the first filament structure described, it is vitally important that the various strand currents be maintained very nearly equal in order to keep the resultant magnetic forces at a safe value. When this structure is operated single phase, however, the tangential magnetic forces are balanced, and its freedom from expansion difficulties makes it an extremely rugged filament.

Effect of Phase Unbalance

Experience has shown that the normal variation between phase voltages on the average power line is of sufficient magnitude to reduce materially the life of a multiphase filament unless elaborate means for continuously maintaining accurate phase voltage balance are provided. Means must also be provided for the immediate removal of filament power in the event of failure of one phase of the power line. The cost of these protective devices will more than offset any saving in cost of filament transformers effected by multiphase filament operation.

The single strand type of filament structure as used in the type 862 tube requires that the phase voltages shall not differ by more than 0.5% if maximum tube life is to be obtained. The hairpin type of filament as used in the Federal F-124-A tube will permit a maximum phase unbalance of 1%.

When either of these types of filament is operated with single-phase filament power, the difficulties with phase unbalance are eliminated. In order to realize this advantage, however, it is important that good connections be made to the filament terminals. If poor contact exists on any terminal the current into that terminal will be reduced and the effect will be the same as for unbalance in multiphase operation. It is obviously also important, as has been pointed out, that the proper terminal connections be made. Experience has shown that when a filament structure which is designed to allow individual expansion of the filament strands is operated single-phase with proper observance of these precautions, greatly improved life results as compared to multiphase operation or to the older type of structure. Even the older type which does not allow free expansion of individual strands will show longer life when operated single-phase because of the elimination of the difficulty of phase unbalance.

Load on Power Line

The third advantage claimed for the multiphase filament operation was that of balancing the load placed upon the power lines. If in the usual transmitter with its several power supplies and separate stages, consideration is given to distributing the various components of the load between phases, it will usually be possible to effect satisfactory balance. Compared to the economic advantages of increased tube life to be expected from single-phase operation, the argument for balancing the filament supply load seems insignificant.

[Continued on page 76]

COMMUNICATION and CONTROL RELAYS

GEOFFREY HERBERT

A comprehensive survey of various types of relays, with practical data regarding their characteristics and applications in radio apparatus

THE BASIC function of a relay is to control a large amount of power with a small amount of power. Consequently, relays are frequently considered primitive relatives in the family of power amplifiers and electron tubes, which have greatly surpassed the relay in speed of response, accurate timing, and graduated degree of power level. These advantages of the electron tube are negated by the costs of extremely low efficiency, relatively short life and high maintenance, complicated equipment, comparative bulk and high initial cost of supplementary equipment. The relay offers tremendous power capacity for its size, compactness, exceptionally high efficiency, and a low initial cost. Where loads are not interrupted frequently, an almost endless life with practically no maintenance can be expected of the relay.

Practically, these differences in performance between relays and electron tubes are only relative, and none of

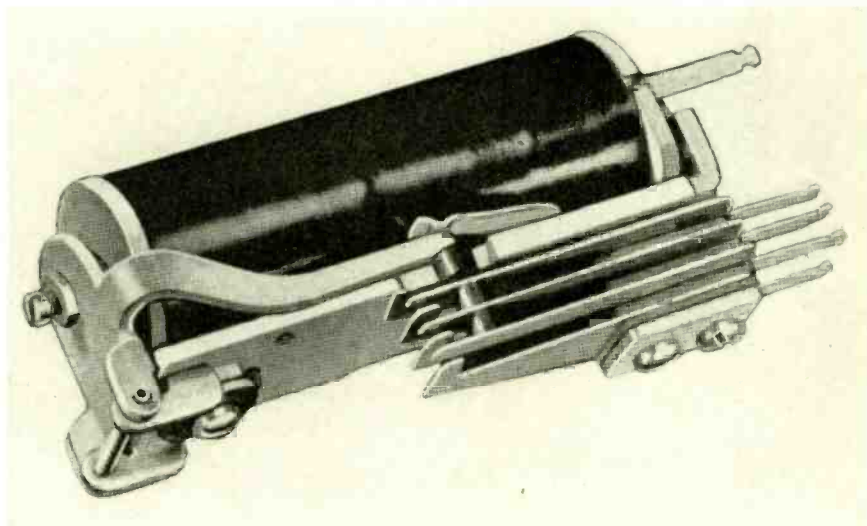

Fig. 2. Telephone-type relay

(Courtesy Automatic Electric Sales Corp.)

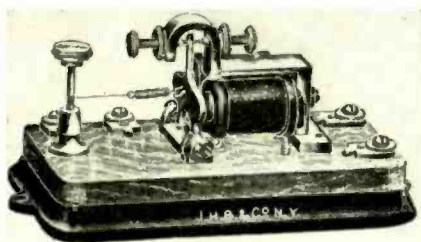

Fig. 1. Pony relay

(Courtesy J. H. Bunnell and Co.)

these advantageous characteristics belongs exclusively to either. Only by enumerating the important characteristics of each of the various forms of relays can the fields of application in which the relay is superior be determined. Just as hundreds of electron tubes have each been designed expressly for a certain task, thus have a like large number of relays been developed for given applications. As an example, the sensitive relay is analogous to a triple grid control amplifier tube and, at the other extreme, the contactors used in

aircraft controls are similar to the thyatron gas tube.

At present, there are no classifications which are officially adopted throughout industry, for relays. Classifications which are based on function and operating requirements have been widely accepted for several years for electron tubes. Since relays do not require frequent replacement as do electron tubes, the need for all manufacturers to produce interchangeable items did not exist for relays except where the demand for a certain type was large enough to jus-

tify competition. However, the industry does employ a common language which is well understood in the trade and the terms used here are representative.

To present a survey of what the relay industry has to offer, it will be useful to divide relays into certain classifications whose names will indicate the most prominent features by which they are known. Under each classification, the major constructional and design features are described and an analysis of their effect on the performance is made. The range of operating characteristics for coil and contacts is specified for each general classification.

In Fig. 1 is shown a picture of one of the early Pony relays used in telegraphy. These were used primarily for retransmitting messages when the original signal could not be carried any further through the circuit without weakening to an unusable extent. Since that time relays have been developed by the thousands. However, many of them still have the same basic weaknesses that this Pony relay had. These weaknesses, to be referred to, are not a condemnation of these relays. Most of them were built to be mounted on a table, a wall or a large panel in some control room. That they could work in only one position, that a slight vibration would open the contact circuit, that they needed continual adjustment and that they were susceptible to undervoltage drop-out—none of these reasons seemed important to the original users and designers of these relays. The first relays that went on shipboard, on aircraft, and on moving or vibrating equipment used these relays that were so inadequate. Today, our needs have

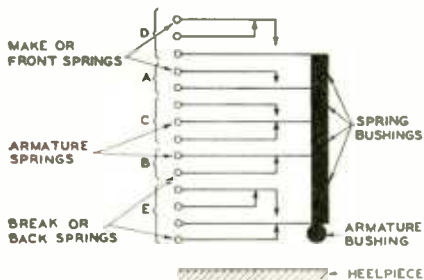

Fig 5. Schematic showing spring arrangement

brought forth the refinement of the old and the development of the new.

The relays presented here are those that, in the collective judgment of relay makers and users, have the best features for their respective category. This is attested to by the fact that almost every type described is made by at least four manufacturers.

These relays will generally meet all of the latest government requirements for performance, under service conditions.

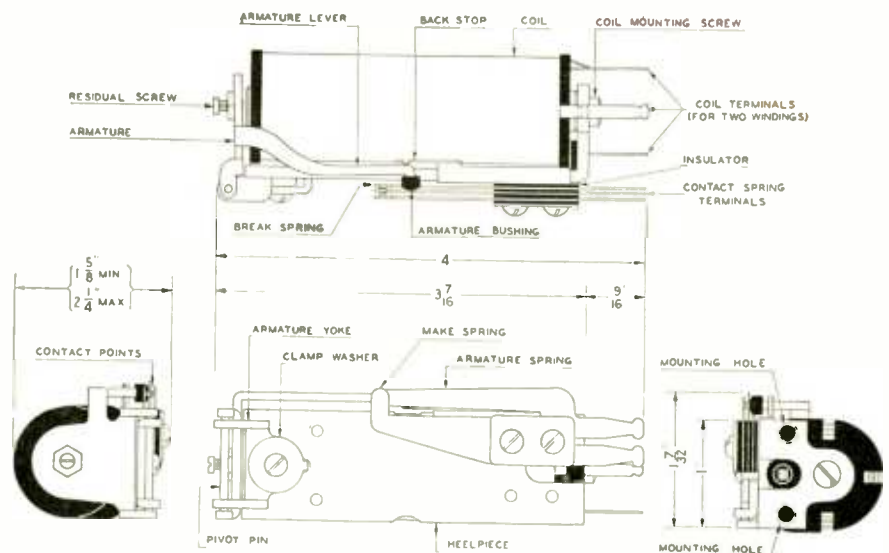

Fig. 3. Design drawing of telephone-type relay
(Courtesy Automatic Electrical Sales Corp.)

Telephone Type

With the development of manual and automatic telephone switching equipment on a world-wide basis, a line of "telephone-type" relays evolved which are standard on almost all these equipments. Although made by more than a half-dozen manufacturers, the relays of all the producers are interchangeable in mounting and function. The design of these relays has been refined to the point where each detail of the relay is substantially alike for all manufacturers. This leaves little to choose from in unusual design features and permits them to be evaluated principally on the excellence of materials and workmanship. Careful examination of Figs. 2 and 3 will show all of the principal design features of this type of relay. Of all the types of relay manufactured, this type offers the greatest flexibility in modifications to meet almost any operating requirements. It deserves the title of "General-Purpose relay" more than any other because of the ease and economy with which multi-wound coils, time-delay characteristics of either slow-operating or slow-releasing action, and an almost unlimited variety of contact arrangements can be furnished by assembly from standard stock parts.

In Fig. 3, these parts are identified with the commonly used designations and typical dimensions. The frame is an

"L" shaped strip, the "heelpiece" end of which is also the mounting surface. Fastened to the heelpiece is a long cylindrical core and coil. At the opposite end of the frame is clamped a hinge for the armature. The standard armature bearing is usually a reamed brass yoke with a drawn phosphor-bronze pin. For continuous operation, an alloy bronze bearing with stainless steel pin or an equally tough combination of materials is used. For high-speed operation, oil-impregnated porous-metal inserts can be used. These extra-duty bearings are not necessary for average purposes, but find their field of use where the relay must retain its adjustments for sensitivity or time-delay in spite of severe duty. The use of oil on the bearings is not recommended unless the relays are completely protected from dust and grit. The abrasive particles adhere to the oily surfaces and increase the wear. The adjustable residual-gap screw is usually employed only where the point of release is critical, such as close-differential or time delay operation. Ordinarily a disc of non-magnetic material is welded to either the inside of the armature or end of coil core. The thickness of this spacer is chosen to secure drop-out at the desired voltage and to prevent sticking due to residual magnetism. The armature pivots on the hinge and has either one of two arms which operate the contact-spring pile-

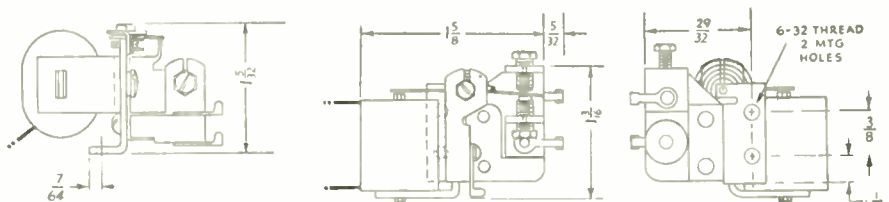

Fig. 4. Relay drawing illustrating function of springs

CONTACT TABLE	
Material	RATING A.C.—Non-Inductive
Code No. 1 Silver	1 Amp. 50 Watts
Code No. 2 Silver	2 Amp. 125 Watts
Code No. 3 Silver	4 Amp. 450 Watts
Code No. 4 Palladium	3 Amp. 150 Watts
Code No. 5 Palladium	4 Amp. 175 Watts
Code No. 6 Plat.-Iridium	3 Amp. 150 Watts
Code No. 7 Plat.-Iridium	4 Amp. 175 Watts
Code No. 8 Low. Steel-Silver	4 Amp. 200 Watts
Code No. 10 Elkonium	4 Amp. 200 Watts
Code No. 11 Tungsten	3 Amp. 450 Watts
Code No. 12 Tungsten	4 Amp. 500 Watts

Fig. 6. Typical contact rating table

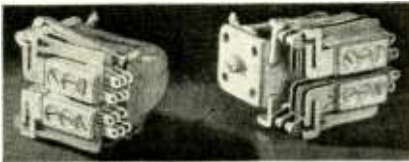

Fig. 10. Small telephone-type relay
(Courtesy Automatic Electrical Sales Corp.)



Fig. 13. Sensitive relay

(Courtesy Sigma Instruments, Inc.)

ups and amplify the motion of the armature proper.

The parts thus far described perform the mechanical actuation. The spring pile-up does the switching. A spring assembly may be mounted on either side or on the both sides of the heelpiece. The construction of the spring pile-up can be observed in Figs. 2 and 3 and the function of the springs is shown in Figs. 4 and 5. The pile-up consists of alternate stationary springs and armature springs which are actuated by the armature arm. The stationary or make spring is shorter and wider than the armature spring. The make spring is thus stiffer and the difference in length creates a small amount of wiping action as the contacts are closed. The spring and terminal are of one piece construction. The springs are separated by phenolic insulation about 1/16 inch thick. The complete spring pile-up is clamped under pressure and given a heat-treatment before the screws, made of a high-tensile-strength steel, are fastened with power-driven screwdrivers. This method of assembly is used to prevent loosening of the springs from "cold flow" of the insulation. Where the insulation is to be tested above 500 V.A.C. between springs and between springs and frame, either two insulators may be placed between adjacent springs or an insulator which is longer and wider than a standard insulator can be also added to form an external barrier. A phenolic tube is also used around each of the pile-up assembly screws. Since these insulators

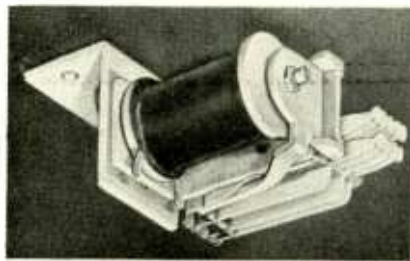

Fig. 7. Short telephone relay
(Courtesy Automatic Electrical Sales Corp.)

are usually punched from paper of linen bakelite, the edges are susceptible to moisture absorption and will also support the growth of fungus. As a preventive, the insulators should be treated with a fungicidal varnish before assembly. The end of the armature arm is capped with a bakelite bushing. Small pins are welded or riveted to the contact springs to support the bakelite insulating spacers between the armature springs.

The contact springs are usually made of an 18% nickel silver (actually 18% nickel, 65% copper, 17% zinc) rolled to a spring temper hardness. Since the electrical conductivity of nickel silver is only about 6% of copper, other spring materials such as phosphor-bronze or beryllium copper can be used to reduce the voltage drop through the springs.

The contacts at the tip of the spring are usually hemispherical in shape to permit good contact in spite of slight misalignments. Due to the burning of the contacts by the arc created by the opening of the contacts under load, it is necessary to use alloys of noble metals which can stand this heat and yet not oxidize rapidly. Typical alloy contacts in diameters from 1/16 to 3/16 inch are shown with their current ratings in Fig. 6. The ratings apply to the contacts in carrying position (closed) and also to the make or break of non-inductive (resistance) loads on alternating current. Where inductive loads such as motors are present, the rating shown must be reduced by one-half or more.

Specifications—

Coil—Wound for voltages from 2

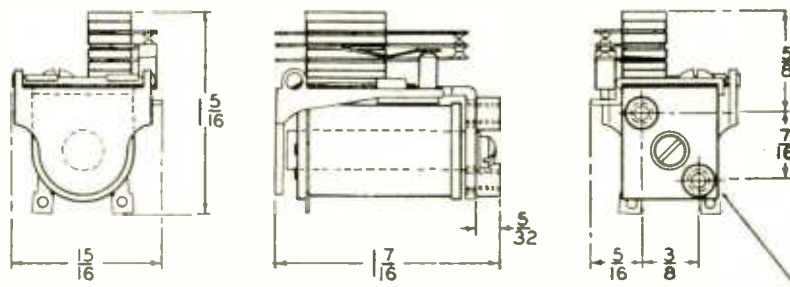

Fig. 11. Midget relay
(Courtesy Automatic Electrical Sales Corp.)

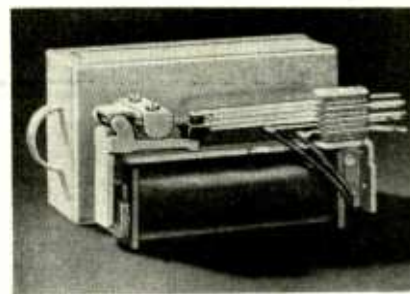

Fig. 3. Typical a-c relay
(Courtesy Automatic Electrical Sales Corp.)

V.D.C. to 300 V.D.C. Wattage demand from—1 watt for small contact arrangements to approximately 10 watts.

Contact Arrangement. All forms of switching shown in Fig. 4. Maximum of 12 springs in each pile-up, a total of 24.

Operate Time—Range 0.002 to 0.025 sec.

Release Time—Range, 0.005 to 0.025 sec.

Some relays are designed with twin contacts. Although the spring functions as a single contact, it is designed with a bifurcated arm on which independent contacts are mounted. If dust or grit prevent one of the two arms from closing, the other spring arm can complete its travel and make firm contact. This form of contact spring can be had whenever the additional reliability is desired.

Short Telephone Relay

This relay is substantially identical to the standard length telephone relay in construction, except that it employs a shorter heelpiece and coil. In order to fit the contact-spring pile-up onto the shorter frame, the pile-up is turned around and fastened to the armature end of the frame. Because of the smaller coil, the sensitivity is reduced and the maximum number of springs in the pile-up is reduced. Without the right-angle mounting bracket shown in Fig. 7 the overall length is 2½ inches. All the other overall dimensions remain the same.

Specifications—

Coil—Wound for voltages up to 135 V.D.C. Wattage demand, about 2.5 watts.

2 MOUNTING STUDS
4-40 TAP



Fig. 17. High-voltage relay
(Courtesy Price Bros.)

Contact Arrangement—All forms of switching shown in Fig. 4. Maximum of 12 springs in one pile-up only.

A-C Telephone Type Relays

The solid core of the conventional telephone relay has very high eddy current losses when placed in an a-c field. In addition, the usual magnetic iron that is used for the core has a severe hysteresis loss. By making the core of laminated silicon-steel where the flux density is greatest, the principal losses will be reduced sufficiently. In Fig. 9 is shown such a design. The overall dimensions remain the same for both the standard length and short telephone types. The armature end of the laminated core is slotted across the center. Then a copper shading ring is fitted over one of the legs into the slot and staked in. The delayed magnetic flux set up by the induced currents in the shading ring, prevents the armature from chattering as the alternating current in the coil goes through zero twice each cycle.

Specifications—

Coil—Operating voltage up to 220 A.C., 20 to 60 cycle. Power demand, 4 to 6 V.A. for standard, 10 V.A. for short.

Contact Arrangement—All forms of switching shown in Fig. 4. Standard—Maximum of 6 springs in each pile-up, a total of 12. Short—Maximum of 12 springs in one pile-up only.

Small Telephone Type Relay

This small relay, because of its basic similarity to the standard telephone relay, can match it for many light-duty applications. Although not as sensitive, nor capable of operating as many contact springs, it provides all of the other features in regard to contact arrangements. Its construction and typical dimensions are shown in Figs. 10 and 11. Where light weight (approximate weight is 2 oz.) and compactness are at a premium as in aircraft, this relay has no equal.

In Fig. 12 are shown two new developments that increase the usefulness of this relay. The hinge pin, as has been

pointed out in the discussion on standard telephone relays is subject to wear affecting the adjustments and may even stick completely. Beryllium-copper, noted for its fatigue resistance, is used as a spring hinge. A thin strip of beryllium copper is stamped out so that the center of the hinge has no material in it. Sufficient strength is secured from the ends alone and the power required to flex the spring is reduced. One end of the leaf spring is secured under the contact-spring pile-up and the other is riveted to the armature. Only a very small gap is left between the frame and armature. Relays have passed over 50 million operations with this type of hinge.

For U.H.F. a new type of contact spring is available. The usual contact springs are mounted with a large portion of their flat sides facing one another. When mounted in this fashion, the maximum capacitance exists between them. For ultra high frequencies, the losses due to this capacitance, to the proximity of the contact-springs to the steel screws, and to ordinary phenolic insulation become serious. To avoid these losses the contact springs lead in from opposite sides of the pile-up and are riveted to the sides of low-loss mica-filled bakelite insulators. The bushings which actuate the springs are of steatite.

Specifications—

Coil—Operating voltage up to 115 V.D.C. Wattage demand—1.5 to 2 watts.

Contact Arrangement—All forms of switching shown in Fig. 4. Maximum of 6 springs in each pile-up, a total of 12. Rating—Make or break 50 watts (max. 1 amp.) non-inductive load. Make or break 25 watts (max. 1/2 amp.) inductive load. Carry 100 watts (max. 2 amp.) any load.

Sensitive Relay

All relays are potentially sensitive relays. To qualify though, every one of the variables which enter into the manufacture of a relay must be controlled in

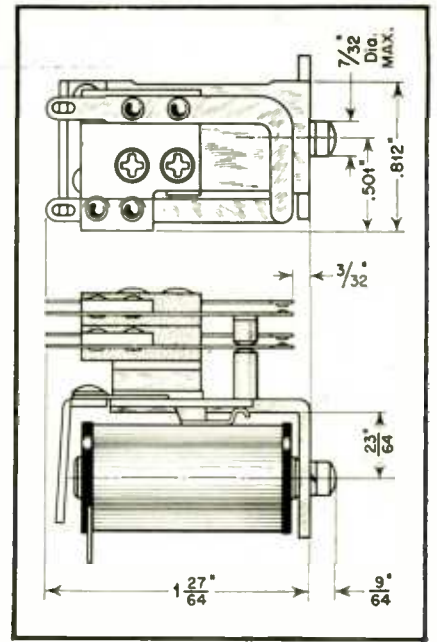

Fig. 12. Relay using new hinge pin construction
(Courtesy RBM Co.)



Fig. 15. Midget Relay
(Courtesy Price Bros.)

order to secure maximum sensitivity and reproducible characteristics. The magnetic properties of the iron which are the principal factor in determining the sensitivity are dependent on the type of material used and the subsequent

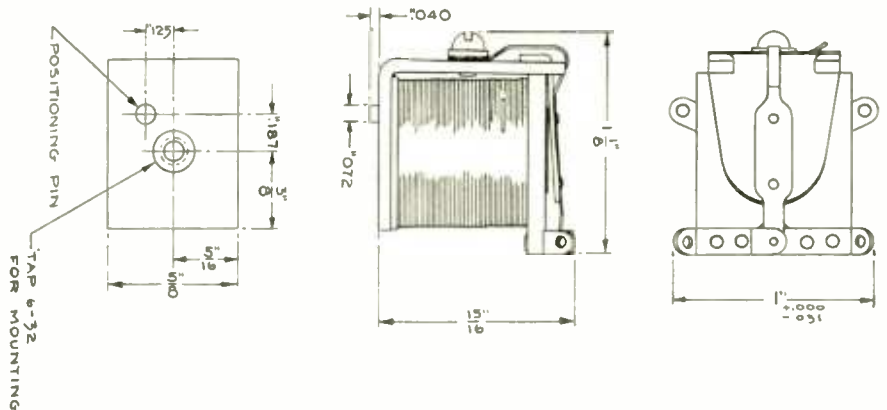

Fig. 16. Design details of midget relay
(Courtesy Price Bros.)

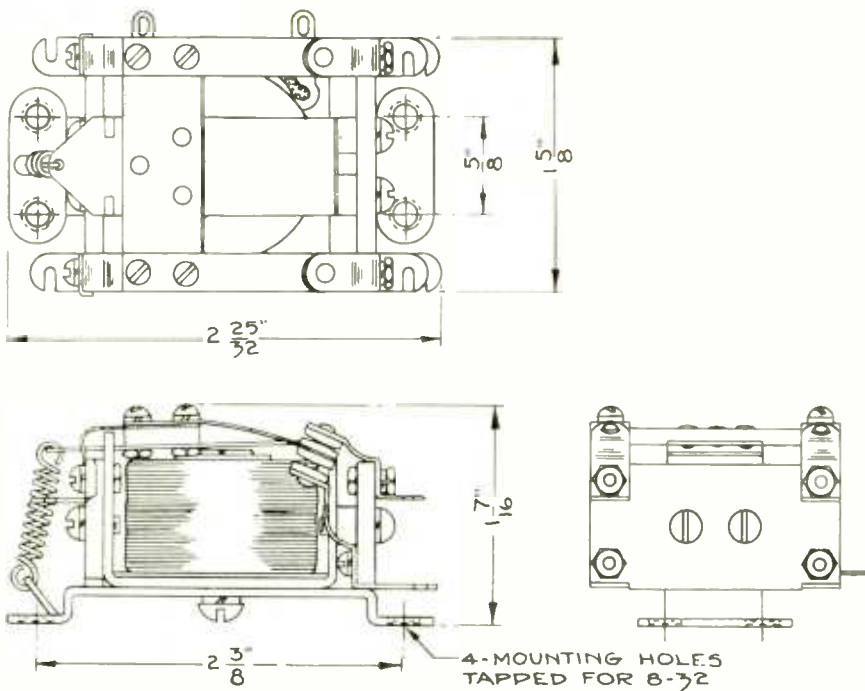

Fig. 18. Design details of high-voltage relay
(Courtesy Price Bros.)

heat treatment. The material usually employed for ordinary relay work is popularly referred to as Magnetic Armco Iron. This is essentially a pure iron, 99.8% minimum. However at lower magnetizing forces, this iron will age (change magnetic properties) and thereby disturb the initial adjustments. Temperatures above 125°F also accelerate this aging. A material which has about the same magnetization properties and is free from aging is a high-silicon relay steel. This material of about 4% silicon is substantially the same alloy that is used for transformer laminations but is processed to permit easier bending and machining. The strains set-up in punching and bending reduce the permeability of the material. To secure best magnetic performance, the material is annealed after fabrication at 1500 to 1550°F.

Since it is impractical to control manufacturing tolerances any closer, numerous adjusting screws in self-locking brackets control the positioning of the residual gap between core and armature, the gap between contacts, and spring tension. Typical construction is illustrated in Fig. 13. To gain maximum sensitivity, the contact spring load on the armature must be very light. Therefore the contact arrangement is never more than S.P.D.T. (single pole, double throw).

Specifications—

Coil—Operating voltage up to 25 V.D.C. Wattage demand—6 to 50 milliwatts. Differential (between closing and drop-out current values)—5% min.

Contact Arrangement — S.P.D.T. Rating—150 watts at 110 V.A.C. non-

inductive. 1 amp at 48 V.D.C. non-inductive.

These relays cannot be satisfactorily made for coil operation on A.C. To do so loses most of the desirable properties. A small copper oxide or selenium rectifier will permit their use on A.C. However, even if a capacitor is used across the relay coil to smooth the ripple from the rectifier and thus stop any tendency to chatter, the accuracy of the relay will be impaired though the sensitivity remains high. All rectifiers are notorious for their aging (change of internal resistance with use) and large negative temperature coefficient.

Midget Relay

These are the smallest commercial relays available. They have no unusual characteristics except their size. The relay shown in Figs. 15 and 16 weighs approximately one ounce and is available only in single pole. They are especially useful for operating small indicators. The relay is mounted by a single screw, and is prevented from turning by the positioning pin.

Specifications—

Coil—Operating voltage up to 24 V.D.C. Wattage demand—45 watts.

Contact Arrangement—S.P.D.T. or less. Rating—½ amp. at 110 V.A.C. non-inductive (palladium). 1 amp. at 48 V.D.C. non-inductive.

High-Voltage Relay

For keying low power radio transmitters, power supplies on receivers and amplifiers, this relay offers the greatest adaptability. Estimated in terms of current capacity, it is not the most compact and when more than two poles are required, it appears top heavy due to the overhang of the contact springs. But measured by the voltage which the contacts will handle, the design is well proportioned. The insulation between contacts and between contacts and frame is sufficient to withstand 1000 V.A.C. continuously. Still higher voltages can be handled by spacing the contact arms further out from the sides of the frame. For use on commercial frequencies the insulation can be of bakelite. For radio frequencies the insulation will be low-loss steatite. For high voltages of any frequency, it is preferable to use steatite. Surface creepage across bakelite results in carbon tracking which becomes progressively worse until total failure occurs.

In Figs. 17 and 18 is shown the typical form of construction. The contacts shown in the center are auxiliary contacts for the operation of accessories. The main contacts are ¼ inch diameter fine silver. The faces of the contacts are

[Continued on page 74]

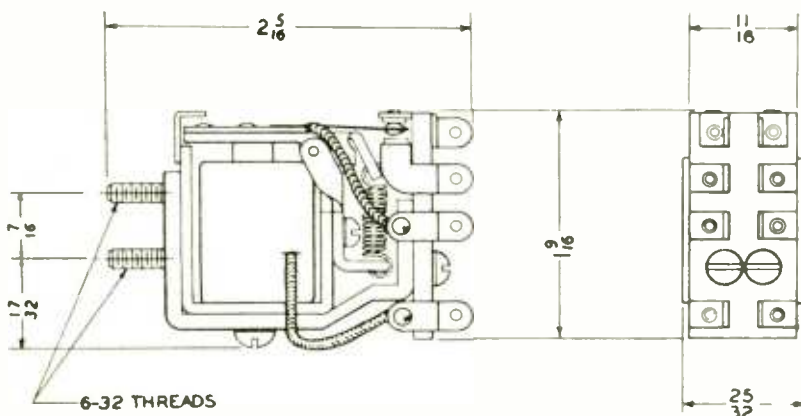

Fig. 20. Design of low power relay
(Courtesy Allied Control Co.)

Measuring Resistance of HOT FILAMENTS

A. K. McLAREN

A simple bridge for measurements where resistance changes with temperature

A method of measuring the resistance of hot filaments or other elements where the resistance changes with temperature may be valuable in cases where these elements are used in circuits requiring close voltage tolerances. Accurate measurements may be made with a small amount of equipment and little trouble if some precautions are observed in making adjustments and taking readings. A 10,000 ohm potentiometer, an a-c volt-ohm meter, a small transformer and some resistors are all that is necessary to make the measurements. A bridge circuit is used and the range is from one or two ohms up to several thousand.

The bridge is set up as in Fig. 1, and the 10,000-ohm potentiometer may be mounted on any insulated panel. Some care must be used when employing the higher voltages, to prevent shock or damage due to short circuits. The power

supply may be a transformer or, for the higher wattage lamps, the power may be taken directly from the 110-volt mains. A small transformer for the smaller lamps and for use when re-balancing the bridge is also required. The wattage rating of R_2 must be such that it will not be overloaded for the various lamps and the watts consumed by this resistor will be about one-tenth that of the lamp being measured.

It will be seen that the lamp is connected in one side of the bridge and is lighted by the current passing through the bridge. The power is turned on and the bridge is balanced by adjusting R_1 until the voltmeter reading is a minimum. It is best to use the higher voltmeter ranges until the minimum point is found and then switch to the lower ranges for most accurate adjustments. After R_1 is adjusted to the minimum point it is left as it is and the power

disconnected if using the higher voltages. A variable resistor is substituted for the lamp and the bridge connected to the small transformer (about 10 volts). The resistor R_x is then adjusted until the bridge is again balanced. Resistor R_x is left at this setting, disconnected from the bridge and its resistance is then measured on the ohmmeter. The resistance indicated by this reading will be equal to the resistance of the lamp.

Range

The range of the bridge with any standard used will be about 100 to 1; that is, with a standard of 10 ohms for R_2 , the range will be from 1 ohm to 100 ohms. With a resistance at R_2 of 10 ohms, lamps with resistances of 1 ohm to 100 ohms may be measured. With lamps of lower current a resistance of 100 ohms at R_2 will give a range up to 1,000 ohms and down to 10 ohms. However, the lower the resistance of R_2 , the more accurate the resistance measurements will be, due to less voltage drop in R_2 , and therefore less heating.

If the resistance of lamps at full voltage is required, the voltage should be measured across the lamp while in the bridge. The voltage across the bridge will have to be raised to overcome the voltage drop in R_2 . In measuring low voltage lamps the small transformer may be used as power supply in both balancing operations. Measurements may be made for any brilliancy of the lamp by varying the voltage input to the bridge. Several readings at different voltages may be taken and a curve drawn on cross-section paper for later reference.

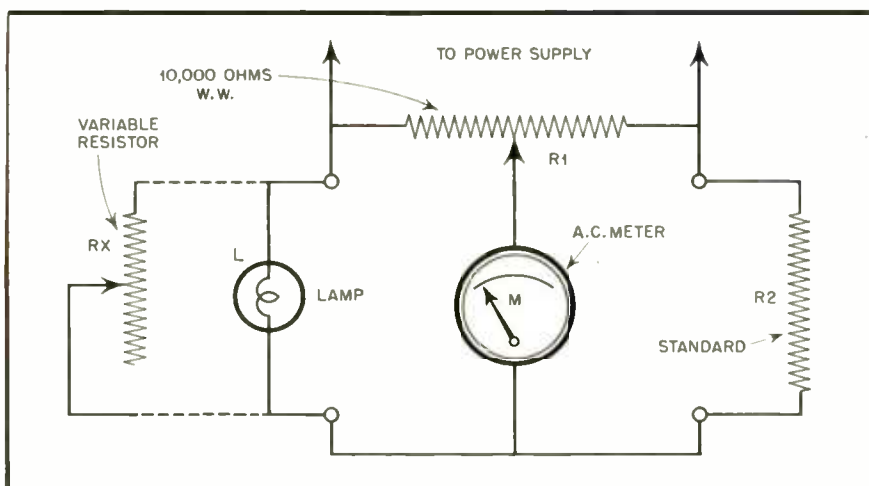
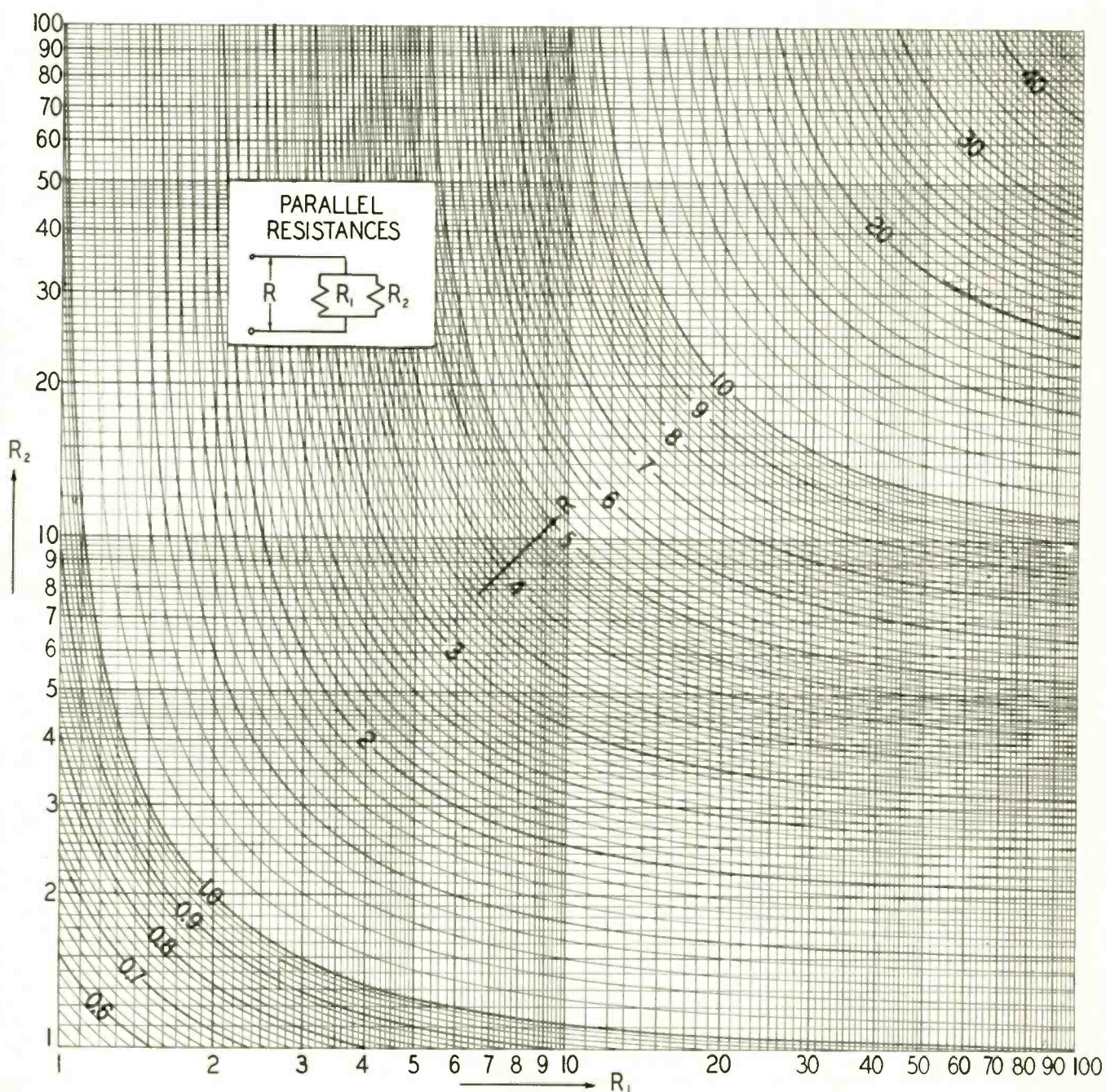

Fig. 1. This resistance bridge is simple in design and covers a wide range

PARALLEL RESISTANCE CHART

C. J. MERCHANT
Brush Development Co.

This chart gives constant percentage error within 1% for the resultant parallel resistance



RADIO DESIGN WORKSHEET

NO. 34—AUDIO TRANSFORMERS IN MULTIPLE OR SERIES; POLYPHASE CIRCUITS

AUDIO TRANSFORMERS IN MULTIPLE OR SERIES

In *Fig. 1*, assume the two audio transformers operate from a source impedance of 1000 ohms. Let transformer *A* feed a 100-ohm load and transformer *B* feed a 10-ohm load. If maximum power is to be delivered to the transformer loads, the 1000-ohm source impedance must be terminated by 1000 ohms. That is, the parallel impedance presented by the primaries of transformers *A* and *B* must be 1000 ohms.

Thus

$$1000\omega = R_1 R_2 / R_1 + R_2 \dots (1)$$

Now, the impedance ratio of transformer *A* is $R_1/100$, and of transformer *B* is $R_2/10$.

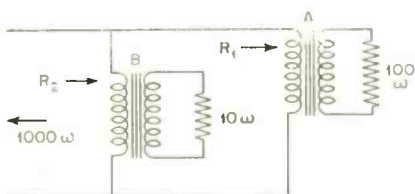

Figure 1

If transformer *A* is to deliver 1 watt to its load of 100 ohms and transformer *B* is to deliver 2 watts to its load of 10 ohms, then

$$R_1 = 2R_2$$

since power is absorbed in inverse ratio to the impedance presented to the source by the two primaries. Whence

$$1000 = \frac{2R_2 \times R_2/2R_2 + R_2}{2R_2(R_2)/3R_2} = \frac{2R_2}{3}$$

and

$$R_2 = \frac{3}{2} 1000 = 1500\omega$$

Likewise, since $R_1 = 2R_2$ we have

$$R_1 = 2(1500) = 3000\omega$$

We can check the validity of this by substituting these values in the right hand side of equation (1)

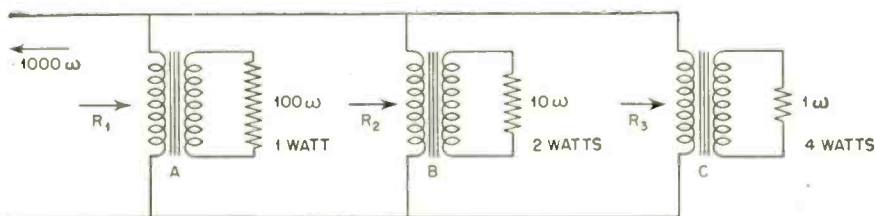

Figure 2

$$\frac{R_1 R_2}{R_1 + R_2} = \frac{3000 \times 1500}{3000 + 1500} = \frac{45 \times 10^5}{45 \cdot 10^2} = \frac{10^3}{10^2} = 10^3 = 1000\omega$$

$$R_3 = \frac{14000}{8} = 1750\omega$$

$$R_2 = 2R_3 = 3500\omega$$

$$R_1 = 4R_3 = 7000\omega$$

This of course assumes unity coupling in both transformer and zero losses; i.e., a perfect transformer. This is a valid assumption for a good transformer which will dissipate only a few per cent of the power internally. Thus, the impedance transformation of *A* is 3000/100 and of *B* is 1500/10.

Assume a similar situation with three transformers *A*, *B* and *C*. Let

- A* deliver 1 watt
- B* deliver 2 watts
- C* deliver 4 watts

as shown in *Fig. 3*.

$$R_1 = 2R_2 = 4R_3 \quad R_2 = 2R_3$$

Whence we have

$$1000 = \frac{R_1 R_2 R_3}{R_2 R_3 + R_1 R_3 + R_1 R_2}$$

$$1000 = \frac{4R_3 \times 2R_3 \times R_3}{2R_3(R_3) + 4R_3(R_3) + 8R_3(R_3)} = \frac{8R_3}{14}$$

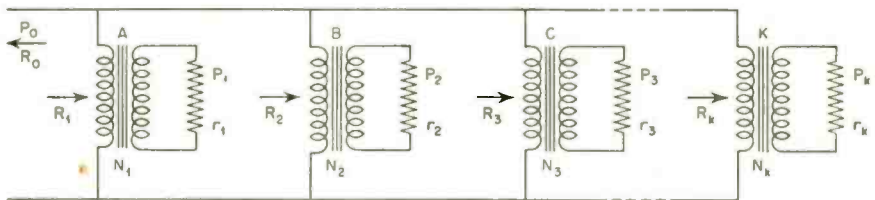

Figure 3

and the impedance ratios of the three transformers are

$$A = 7000/100$$

$$B = 3500/10$$

$$C = 1750/1$$

The above procedure can be used for any desired number of audio transformers in multiple. However, we can deduct from the above a formula to cover the general case so that transformer ratios may be obtained by one substitution. In *Fig. 3* is illustrated the general case with *K* transformers connected in multiple to a source of power-generating capacity *P*, and impedance R_o . The impedance of each transformer is indicated by *N* with the proper subscript. It is obvious from the preceding discussion that ratio N_k will vary with the ratio of secondary

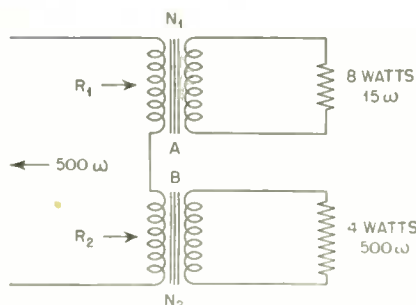

Figure 4

impedance to source impedance $\frac{\sqrt{k}}{R_o}$

It is also obvious that the impedance ratio varies with the ratio of absorbed power to available power $\frac{P_k}{P_o}$

It would therefore seem logical to expect that the product of these two ratios might yield the desired value of N_k , i.e.,

$$N_k = \frac{\sqrt{k}}{\sqrt{o}} \times \frac{P_k}{P_o}$$

Checking this for the case of transformer A in the first example above we have

$$N_1 = \frac{100}{1000} \times \frac{1}{3} = \frac{100}{3000}$$

Checking this for transformer C in the second example yields:

$$\frac{\sqrt{3} P_3}{\sqrt{o} P_o} = \frac{1}{1000} \times \frac{4}{7} = \frac{4}{7000} = \frac{1}{1750}$$

The formula therefore appears to check, so we may write

$$N_1 = \frac{\sqrt{1}}{R_o} \times \frac{P_1}{P_o}$$

$$N_2 = \frac{\sqrt{2}}{R_o} \times \frac{P_2}{P_o}$$

$$N_k = \frac{\sqrt{k}}{R_o} \times \frac{P_k}{P_o}$$

which is the general expression (2)

Obviously, if there are a number of different loads to be supplied with various amounts of power from a single source, the transformers may be connected in series instead of multiple. This is illustrated in Fig. 5, in which it is required to furnish 8 watts of power to a 15-ohm load and 4 watts to a 500-ohm load. If two resistors are connected in series across a source of power, the power absorbed by each will be directly proportional to its resistance. Thus, if one series resistance is ten times as great as another it will absorb ten times as much power. From this it follows that the primary of A must present twice as much impedance to the source

as the primary of B. The impedance presented by the primary refers to the impedance looking into the primary with the secondary terminated.

Thus:

$$R_1 + R_2 = \frac{R_1}{2} + 2R_2 = 3R_2 = 500\omega$$

$$R_1 = 167\omega$$

$$R_1 = 2R_2 = 334\omega$$

Whence:

$$N_1 = 15/334$$

$$N_2 = 500/167$$

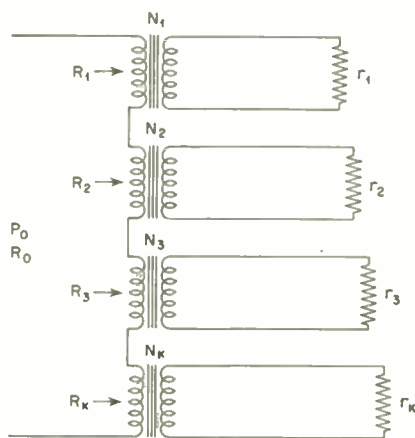

Figure 5

Fig. 6 represents the general phase of K transformers in series. It would seem reasonable to expect that a general formula similar to (2) could be devised for this case. However, the impedance presented to the power source in one case is directly proportional to the power absorbed and in the other case is inversely proportional to the power absorbed. It would therefore seem logical to expect that

$$N_k = \frac{\sqrt{k}}{\sqrt{o}} \frac{P_o}{P_k}$$

If this is checked in the case of the transformers discussed in the example immediately preceding we find:

$$N_1 = \frac{15}{500} \times \frac{12}{8} = \frac{180}{5000} = \frac{15}{500}$$

$$N_2 = \frac{12}{500} \times \frac{4}{7} = \frac{48}{3500} = \frac{12}{875}$$

Whence we may conclude that

$$N_k = \frac{\sqrt{k}}{\sqrt{o}} \times \frac{P_o}{P_k}$$

is the usual expression for audio transformers connected in series to a common source.

POLYPHASE CIRCUITS

In Radio Design Worksheet No. 24 there appeared a brief discussion of the Scott connection of a transformer. This

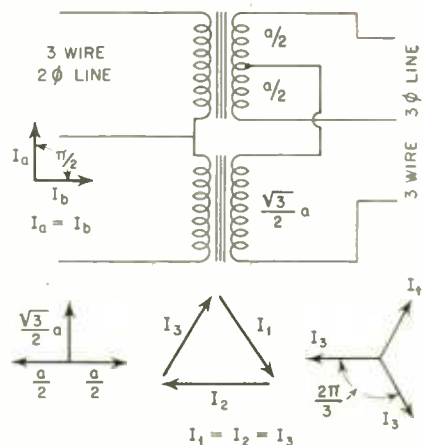

Figure 6

connection is intended to transform two-phase quadrature voltages to three-phase voltages with 120 degrees mutual phase difference. The Scott connection is shown in Fig. 6. The Scott transformer is a special case of a more general theorem. The Scott connection starts with equal quadrature voltages and delivers three equal voltages with equal phase displacement.

Now, in the general case, the two-



Figure 7

phase voltages can be in any case relation except zero and bear any relation in magnitude and a proper connection can be devised to deliver equal three-phase voltages. This requires a proper choice of secondary tap and the number of turns in the secondary winding connected to the tap.

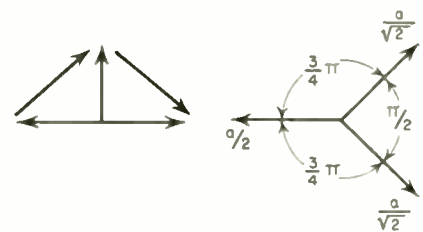

Figure 8

Fig. 7 illustrates the state of affairs when the tap is moved from the central position. Fig. 8 illustrates what happens when the center tap is unchanged but all voltages are equal. Obviously, phase and amplitude may be adjusted to any desired arrangement.

RADIO, April, 1944

This Month

GUN LOCATOR

Recent engineering advances have resulted in the development by the Signal Corps of improvements in sound ranging equipment which are proving important to American artillerymen in locating enemy gun positions.

Accurate sound ranging determines the location of an enemy gun by picking up the sound wave produced by the muzzle blast of the gun. Neutralizing counter battery fire is then employed. This fire takes into account the point of explosion of our own projectiles and the adjustment of our guns to coincide this explosion with the position of enemy guns.

Sound ranging methods now in use require a number of special microphones set up at intervals behind the front lines. Each microphone is connected with the central sound ranging system by wire lines.

The microphones pick up the signal (enemy gun fire or our shell bursts) and this is transmitted to the central station where they are photographically recorded by an oscillograph. From the differences of the times of arrival of the signal at the various microphones the position of the enemy gun is determined by means of geometric calculations.

The new Signal Corps sound ranging set is less than half the size and weight of the equipment used by the Army at the outset of the war, and the photographic recording feature is being replaced by a dry recorder which eliminates the requirement for photographic chemicals.

The microphone array in sound ranging is often spread over a distance of from 10,000 to 15,000 yards. Approximately ten miles of wire are required to connect the microphones to the recording station.

TUBE PRODUCTION

The necessity of increasing future production of radio receiving tubes by more than 3,000,000 tubes a month to meet military requirements was presented to members of the Receiving Tube Scheduling Industry Advisory Committee at a recent meeting with representatives of the Army, Navy and War Production Board, officials of the Radio and Radar Division of WPB said today. Committee members expressed their belief that, upon completion of certain facility expansions, their schedules could be stepped up to take care of the increased military requirements when authorized.

Military demands were reported as still increasing as a result of emergency programs, battle losses and additional requirements from electronic equipment manufacturers, thus reducing the availability of replacement tubes for home receivers.

Requirements for military-type receiving tubes during the first quarter of 1945 are approximately 2,500,000 tubes more than the actual production for military use during the last quarter of 1944. This has made it necessary for the tube manufac-



Winter Gun Practice—A member of the Navy armed gun crew aboard a merchant ship, equipped with Western Electric sound-powered telephone equipment, stands at his position ready to repel submarine attacks. The gunnery officer watches him set the gun's sights.
Official U. S. Navy Photograph.

turers to convert more labor and equipment to the military types and further reduce the number of tubes for civilian use. It is anticipated that in July or August, after the industry has completed its expansion program and after all military needs are scheduled for production, more civilian tubes may be available than there are at present.

Army and Navy officers thanked the industry group for the excellent production job in 1944 and expressed their appreciation for the close cooperation of the tube manufacturers.

A WPB representative reviewed with the committee the critical types of receiving tubes and the members agreed that an all-out effort will be made to schedule and produce these items as they are required by the Army and Navy. It was also announced that unfilled orders for forty types of receiving tubes will be frozen at the factories as of February 1. Shipments to customers are to be authorized and directed by WPB. When these types become less critical at a later date restrictions will be relaxed, it was said.

The Army, Navy and WPB representatives reviewed a list of 60 types of receiving tubes for which there is a small demand and which the industry could not fit into its production schedules due to the need for tubes for which there is a larger military demand. Forty-one of these types of tubes were declared obsolete for the duration, a WPB official said.



Gus Wallin
Galvin Mfg. Company

RAYTHEON AND BELMONT TO MERGE

That tentative negotiations are under way to combine the forces of the Raytheon Manufacturing Co. and the Belmont Radio Corporation was announced today by Lawrence Marshall, president of Raytheon, and Parnell Billings, president of Belmont. The

two firms currently have total annual volume in excess of \$200,000,000.

Belmont, one of the country's largest producers of private brand radio receivers sold through mail order houses, chain stores and other retail outlets, has its plant in Chicago. Raytheon, a leading manufacturer of electronic tubes, operates plants in Newton, and Waltham, Mass.

The contemplated move to unite the firms would combine their large research departments for the development of both radios and tubes. In addition, it would add the Belmont sales organization to Raytheon's distribution facilities.

At the present time both companies are engaged almost entirely in military production, much of which is under security restrictions.

The combination would pave the way for postwar expansion of the joint production facilities in home radio receivers and in tubes, as well as in micro-wave communication, frequency modulation, industrial electronics and television.

BROADCAST SERVICE

The beginnings of the periods when the audio frequencies are off are so synchronized with the basic time service of the U. S. Naval Observatory that they mark accurately the hour and the successive 5-minute periods.

Of the radio frequencies on the air at a given time, the lowest provides service to short distances, and the highest to great distances. Reliable reception is in general possible at all times throughout the United States and the North Atlantic Ocean, and fair reception throughout the world.

Information on how to receive and utilize the service is given in the Bureau's Letter Circular, "Methods of using standard frequencies broadcast by radio", obtainable on request. The Bureau welcomes reports of difficulties, methods of use, or special applications of the service. Correspondence should be addressed National Bureau of Standards, Washington, D. C.

BATTERY PRODUCTION

Production of "B" hearing aid batteries, although maintained at a much higher level than before the war, cannot at all times keep pace with the demand of the growing number of persons using hearing aid instruments, since manufacture of "B" hearing aid batteries cannot be allowed to interfere with the delivery of dry cell batteries urgently needed on the battlefronts, the War Production Board said today.

To stretch the available supply as far as possible and to assure that each "B" hearing aid battery sold is used to the full extent of its normal life, WPB urged each hearing aid user to buy only one "B" hearing aid battery at a time, as needed. Batteries kept in reserve deteriorate rapidly, and their life, when put to use, is shortened correspondingly.

An average of 13,000,000 cells for "B" hearing aid batteries were made and channeled through dealers to civilian hearing aid users per quarter in 1944. This represents between seven and eight times the estimated rate of production of cells for assembly in "B" hearing aid batteries in 1940.

In the first quarter of 1945, WPB, in accordance with current policy concerning all civilian production, will not permit production of cells for "B" hearing aid batteries to exceed the total of 15,000,000 cells achieved in the fourth quarter of 1944, and production may be substantially less than in the fourth quarter.

WPB will continue to take every possible step to help battery manufacturers keep pace with the demands of hearing aid users, many of whom are making highly important contributions to the war effort, the agency said. However, WPB said it could not at any time permit production of "B" hearing aid batteries to be increased to the extent that delivery of dry cell batteries to the battle fronts would be jeopardized.

Hearing aid batteries contain the same type of cell as is used by the armed forces in the operation of communications equipment, bombing and fighter planes, tanks, jeeps, landing craft and other instruments of war requiring radios, telephones, range finders, direction finders and other electronic devices.

Present and future military requirements for dry cell batteries are higher and more urgent than at any other time since the beginning of the war. During the present critical stage of military operations, more men, requiring more equipment and dry cell batteries, are being sent into battle. Until military production goals are met, there can be no large-scale increases in the output of "B" batteries for hearing aid instruments for civilians.

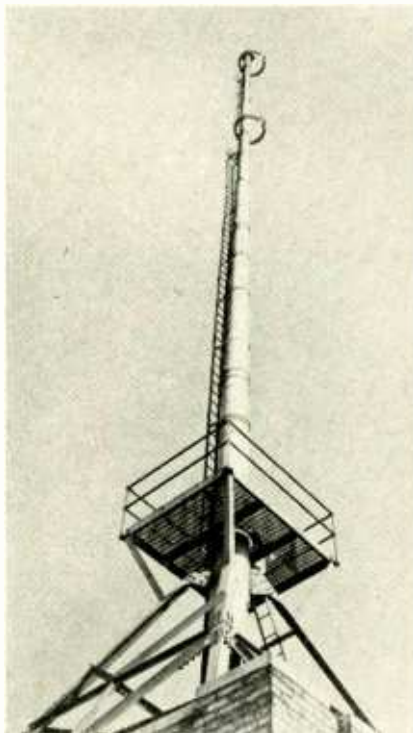

New two-bay General Electric circular antenna recently installed by Columbia Broadcasting System engineers atop the 700-ft. building at 500 5th Ave., New York City, for use by their station WABC-FM. Provision has been made for adding two more bays to this 14-ton structure, which rises to 100 ft. above the roof. When put into use CBS will have the first FM station to cover its assigned area

APPOINTMENTS

John F. Rider

John F. Rider, who entered active service in the U. S. Army on May 1, 1942, with the rank of Captain in the Signal Corps, was recently promoted to Lieutenant Colonel.

From June 1, 1942 to November 17, 1943, Colonel Rider was stationed at the Southern Signal Corps School, Camp Murphy, Fla. Here he organized and became the director of the Training Literature Division. On November 6, 1942, he received his Majority.



John F. Rider

Transferred to Fort Monmouth he organized the Radar Literature Section at the Signal Corps Publication Agency of that Fort. Here Colonel Rider was subsequently advanced to Executive Officer of the Agency and is at present Director in charge of all operations of the Agency. Various literature is prepared at Fort Monmouth covering all Signal Corps equipment procurements as well as special non-equipment Signal Corps Technical and Field Manuals.

E. L. Bragdon

E. L. Bragdon, formerly Trade News Editor of the National Broadcasting Company, has joined the staff of the Department of information of Radio Corporation of America.

Before becoming associated with NBC in 1942, Mr. Bragdon was Radio Editor of the New York SUN, a position he had held since 1923.

A native of Westbrook, Maine, he was graduated as an electrical engineer from Worcester (Mass.) Polytechnic Institute. He is the author of the "Radio Amateur's Handbook."

E. F. Herzog

E. F. Herzog has been appointed designing engineer of the Transmitter Division of the General Electric Company's Electronics Department, according to an announcement by J. J. Farrell, chief engineer of the division.

In this capacity Mr. Herzog will be responsible for the design of all products of the Transmitter Division.

quarters at Schenectady. Since July 1944, he has been assistant to the chief engineer.

Ed DeNike

Ed DeNike who has been Director of Public Relations of National Union Radio Corporation is now Sales Manager of the Distributor Division of that company ac-



Ed DeNike

ording to an announcement this week by H. A. Hutchins, General Sales Manager.

Mr. DeNike resides in Chatham, N. J. and will make his headquarters at the National Union executive offices in Newark, N. J.



Jack Hall
Universal Microphone Co.

A. J. Monack

A. J. Monack was elected Vice President in Charge of Engineering of the Mycalex Corporation of America at a meeting of the Board of Directors held on December 16th. Mr. Monack, who is a graduate of West Virginia University and received a

Master's Degree from the University of Illinois, has been Chief Engineer of the Mycalex Corporation of America since February of 1942. He has also served with the Radio Corporation of America and the Western Electric Company. He was a member of the Staff of the Ceramic Engineering Department of the University of Illinois. Mr. Monack is the author of numerous articles on Ceramics, Glass, Insulations, and Vacuum Tube Materials.

IRE TECHNICAL PAPERS

The following summaries of technical papers presented at the annual meeting of the Institute of Radio Engineers in New York City, Jan. 24-27, 1945, were prepared by the IRE.

Instrument Approach and Landing Systems, by Lt. Col. F. L. Moseley.

This paper reviews the history of Instrument Approach and Landing Systems development from its origin 15 years ago to the present. Fundamental requirements of the low visibility approach and landing problem are discussed and the steps leading up to the adoption of the present United States standard systems are traced.

Equipment now in use both for civil and military purposes is described in some detail. Factors affecting choice of fundamental system parameters are discussed in order to show how the present limits of beam sharpness, indicator sensitivity, rates of descent, spacing of markers, etc., were established.

The pilot's problem in low approach flying is considered and some of the ideal as well as practical aspects of suitable instrumentation are briefly treated.

The Design of Broad-Band Aircraft Antenna Systems, by Captain A. S. Meier, F. D. Bennett, and P. D. Coleman.

Antenna Impedance Measuring Equipment: A coiled-line method of measuring aircraft antenna impedance from 10-80 megacycles is described. The extension of this method to higher frequencies is indicated.

Impedance Matching Sections: Design of two and three element impedance matching sections is discussed. The method is applied to unbalanced antennas and balanced antennas fed from unbalanced lines.

Broad-Band Fan Antennas: The design of broad-band fan antennas on aircraft is reviewed. The requirements to be met by a suitable broad-band antenna are outlined and the means used in meeting these requirements discussed. The design of a matching section for a particular antenna and the increase in band-width obtained is indicated.

Some New Antenna Types and Their Applications, by A. G. Kandoian.

Three newly developed types of antennas will be described. The radiation patterns of each is substantially omnidirectional in the horizontal plane. The first has horizontal polarization, the second vertical polarization, and the third is elliptically or circularly polarized.

Variations of the above types, bandwidth considerations, tuning range, advantages,

and limitations of each type will be discussed as well as the use of these antennas singly or in directive arrays for high-power gain. Applications to very-high-frequency and ultra-high-frequency broadcast, television, and link communication will be considered.

Experimental models and measured characteristics, design and construction for various particular applications, problem of transmission-line efficiency, elimination of balanced feeder, coaxial feeding system and a typical installation will be presented.

Applications of High-Frequency Solid-Dielectric Flexible Lines to Radio Equipments, by H. Busignies.

The importance of the flexible lines in radio design, advantages and inconveniences of solid dielectric transmission lines versus air lines in radio design will be discussed. When the flexible transmission line is of paramount importance, the type of equipments and installations requiring flexible lines will be considered. Examples of applications are ship installations, aircraft installations, ground demountable equipments, and automotive installations. Particular problems involved in the direction finder field, in the instrument landing field, and their solution with solid dielectric flexible transmission lines will be treated.

Radio-Relay Communications Systems in the United States Army, by Lieut.-Colonel William S. Marks, Jr., Captain O. D. Perkins, and W. R. Clark.

This paper describes the use of frequency-modulated very high-frequency radio sets in place of wire lines in Army tactical communication circuits. During the early phases of the war and pending development and production of equipment designed to meet requirements, standard police-type frequency-modulation sets were adapted for use. These were used with great success during the Tunisian, Sicilian, and Italian campaigns. They principally provided simplex teletype circuits from higher headquarters to lower units. By the use of radio repeater or relay stations these circuits were extended several hundred miles. Representative circuits are shown illustrative of employment, distances covered and antenna elevations. A broad-band frequency-modulated very high-frequency set designated AN/TRC-1 was developed for use in conjunction with voice frequency-carrier equipment CF-1 and CF-2 to provide multichannel voice and teletype circuits over a single radio frequency.

This has met with great success and was a most important communication factor in the Normandy Invasion and Battle of France. It marks the first real marriage of wire and radio communications in the Army and provides an integrated communication system. The advantages of a radio system over conventional wire lines under certain conditions are pointed out, such as a saving in men and material, establishment and maintenance of communications in a fast-moving situation, use over water, enemy territory, rugged and mountainous terrain. Expanding and wider application of the principle is indicated.

AMPLITUDE vs. PHASE ANGLE FOR SERIES TUNED CIRCUIT

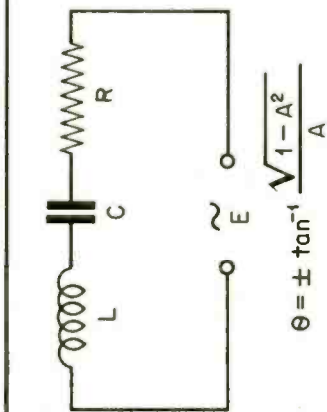

$$I = \frac{E}{\sqrt{R^2 + \left(\omega L - \frac{1}{\omega C}\right)^2}}$$

$A = \frac{I}{I_R} = \frac{\text{CURRENT OFF RESONANCE}}{\text{CURRENT AT RESONANCE}}$

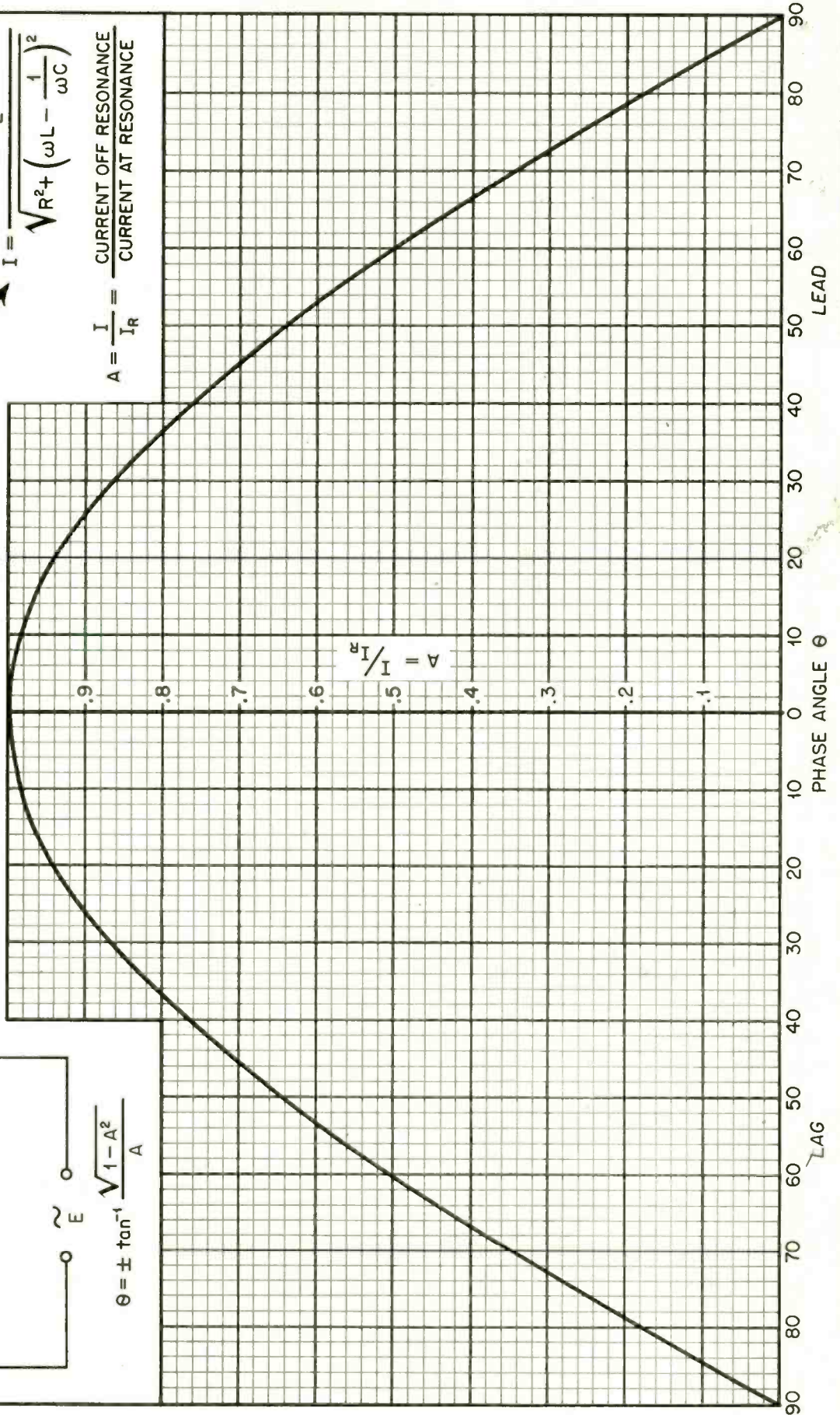

New Products

UNIVERSAL CATALOG

Universal Microphone Co., Inglewood, Cal., has just issued its catalog bulletin no. 1458 on its new D-20 series of dynamic microphones which will be manufactured with a frequency range of 50 to 8,000 cycles and in 50, 200, 500 and 40,000 ohms.

This is the first new microphone from the coast factory since Pearl Harbor. Priority (govt.) regulations will rule the sequence of acceptance of orders and, at such time as the regulation is rescinded, orders will be filled in rotation of acceptance.

The new D-20 is said to be rugged, suitable for extremes of climate, yet of such postwar design that it will fit into new modernized studio settings or those of classic design.

The new micro-adjust swivel is a new departure for microphone use with a P. A. system. It may be positioned anywhere throughout a 60 degree angle without disturbing the balance or appearance of the unit.

The D-20 was designed for recording, public address, transmitters or wherever a full-ranged dynamic is needed. Twenty-five feet of cord, a detachable connector and dust proof cover are included.



TRANSMITTING TUBE SOCKET

A special transmitting tube socket of low loss steatite construction has been announced by the F. F. Johnson Company of Waseca, Minnesota.

It was developed to accommodate the new jumbo 4-prong bases of 8008, BR6, CL146, SC22, GL152, GL159 and GL 169 tubes. Measuring $2\frac{5}{8}$ " x $2\frac{5}{8}$ " by only $\frac{3}{4}$ " thick the socket is smaller than previous designs.

One piece base construction is used with molded in bosses on top of socket, the bosses being ground to present a flat mounting surface underneath a chassis. Cadmium plated brass contacts with steel spring reinforcements are riveted to the ceramic base in such a way that they can not turn.



METAL PARTS

More than 8300 different sizes and shapes of small metal parts are regularly produced for electronic tubes and other precision-built electrical equipments by Sylvania Electric Products Inc. Mass-produced on ultra-high-speed automatic machinery to rigid specifications, parts are supplied in steel, copper, phosphor bronze, nickel, tungsten, beryllium copper and other alloys with carbonized, oxidized or plain finish. Expert product and tool design facilities permit rendering many hard-to-make parts in one-piece at unusually low-cost in quantities of 500,000 or more.

Inquiries regarding small metal parts up to 1/16" thickness are invited and may be addressed to Sylvania Electric Products, Inc., Small Parts Division, Emporium, Pa.

NEW AMPHENOL CATALOG

The release of a new Section "D" for the Amphenol complete catalog describing 26 different types of RG Cables and also many companion High Frequency Connectors for U.H.F. and electronic applications, has been announced by Ben Boldt, Advertising and Sales Promotion Manager of the American Phenolic Corporation, 1830 South 54th Avenue, Chicago 50, Illinois.

This catalog Section brings up to date complete details and specifications governing the production of RG type cables as approved by the Army-Navy R. F. Cable Coordinating Committee for manufacture by this firm. Amphenol's series of low-loss ultra high frequency connectors for use with RG cables are manufactured in accordance with Army-Navy specifications.

Stress is placed on the polyethylene dielectric in the cables making them suitable for use in ultra high frequency and general electronic fields, and on the mica-filled bakelite or polystyrene insulation in the connectors.

The new Section "D" is available free to engineers, electronic maintenance men and experimenters on request addressed to the company.

CERAMIC CAPACITOR DIELECTRIC

The Mycalex Corporation of Clifton, New Jersey announces that it has developed and now has in production a new and advanced grade of Mycalex insulation, designated Mycalex Series K. The new ceramic material is a capacitor dielectric.

The chief advantage of Mycalux K is that it offers a selective range of dielectric constants, from 8 to 15 at one megacycle. In other words, the material can be supplied in various values as to dielectric constant. For example, in applications requiring a dielectric constant of 10, engineers will specify Mycalex K-10. If a dielectric constant of 8 is desired, the application will call for Mycalex

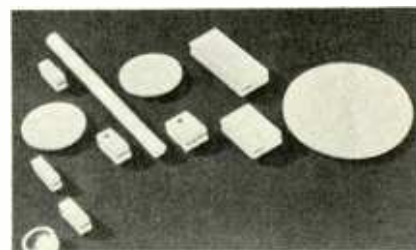

K-8, and so on.

Mycalex K-10 already has been approved by Army and Navy (JAN 1-12) as Class H material.

NARROW LEVER KEY

A new lever key only 7/16" wide, for control purposes in electronic and communications equipment where small size is important, is now being produced by Federal Telephone and Radio Corporation, of Newark, New Jersey.

Though narrower than any other existing key, this reduction in size has been accomplished without any sacrifice in versatility, as the 18 spring capacity permits more than 500 possible switching combinations. Over-all design simplification has resulted in a more rugged, dependable device.



Designed for one or two way, locking or non-locking operation with a positive, snappy action, the entire key assembly is held together by a single screw to facilitate disassembly. The spring pile-up mounts on one side of the two-piece pressed steel frame, with all front posi-

tion springs in one group and all back position springs in another.

Contact springs are of nickel silver with palladium cross-bar contacts, and brass back-stop springs are provided for tension adjustment. Non-click buffer springs are supplied for use in circuits where spring backlash is to be avoided. All springs are interchangeable and the pile-ups may be easily rearranged.

Where necessary this FTR-810 Series Key can be supplied fungus and moisture proofed according to Signal Corps specifications.

PERMOFLUX SPEAKERS

A complete new line of loudspeakers engineered to cover the entire size range from 2" to 15" is announced by Permoflux Corporation, 4900 West Grand Avenue, Chicago 39, Illinois. Speakers are true dimensioned and diaphragms are graduated in 1/2" steps up to and including 7 1/2" with other standard sizes up to 15". The line will provide power handling capacities from 1 to 20 watts and is designed to give acoustical output in 2 db steps. A new magnetic alloy which provides an actual magnetic efficiency of at least three times that of pre-war type magnets, results in considerable weight savings. All speakers are completely dust-proof with metal parts rust-proof finished.

H-F CAPACITORS

A new line of high-frequency, parallel-plate capacitors, designed for use in the resonant circuit, or "tank circuit" of high-frequency electronic oscillators such as those used in electronic-heater equipments, has been announced by the General Electric Company, Schenectady, New York. When connected in parallel with an inductance coil, this class HFP, water-cooled capacitor constitutes the resonant circuit which determines the frequency of the oscillator.

In this application the capacitors are operated at relatively high voltages and may be required to carry heavy currents continuously at frequencies up to several megacycles. The following features make them particularly suitable for this type of service: Low losses at high frequencies; uniformly high dielectric strength; high current rating per unit volume; and convenient mounting and connection facilities. These units are available in standard ratings ranging from 2000 volts, 0.025 microfarad to 9000 volts, 0.0056 microfarad.

SYLVANIA MANUAL

To help radio servicemen during war-time tube shortages, a comprehensive 20-page manual providing practical replacement tube data has been compiled by the Commercial Engineering Department of Sylvania Electric Products Inc., Emporium, Pa. The manual gives full information needed for the adaptation of available tubes to many difference types of radio receivers which may otherwise become inoperative through the failure of original equipment tubes which cannot be immediately obtained.

In addition to a section describing the recommended use of substitute types when

original types are not obtainable, the manual contains specific information for battery, 150 ma., 300 ma., transformer and auto tube types. The information is conveniently tabulated for quick-reference.



Thirty six adaptor circuit diagrams are included for use with the tabulations when changes in tube socket wiring are required. Tabulations are used to indicate the type of changes needed including: filament voltage, filament current, socket wiring, socket type, alignment, top cap connection and changes in bias or plate voltage.

Circuit modifications for battery and AC-DC sets are also described in detail. The manual, size 8 1/2 x 11, is provided with a durable cover. It is distributed free to radio servicemen through Sylvania distributors or direct from Sylvania at Emporium, Pa.

GRAYHILL SWITCH

A small momentary push-button, snap-action switch, designated as the Grayhill Snapit Switch, has been announced by Grayhill. One North Pulaski Road, Chicago 24, Illinois.

The phenolic body of the switch is round and measures only 7/8" in diameter by 1 1/8" high, measured from the top of the push-button to the end of the solder lugs. The switch is mounted by a 3/32



bushing, 7/16" long and held securely by two mounting nuts.

The fixed contacts are of fine silver overlay on phosphor bronze. These contacts are threaded and are held securely in place, the electrical connection being made by brass screws which also hold and secure the two solder lugs. The moving contact which bridges the two fixed contacts is also fine silver overlay on phosphor bronze, which assures posi-

tive contact with the very minimum of contact resistance. The contact gap is .040" on each contact; therefore, the total contact gap which breaks the circuit is .080".

The switch employs a snap action principle which assures fast make and break as well as a contact pressure of approximately 35 grams, making the switch practical for use on d-c current.

The switch operates on a .0625" movement of the push button and carries a current rating of 10 amperes at 115 volts ac, and 2 amperes at 115 volts d-c. It is general practice on d-c current to increase the d-c current rating with a decrease in the voltage.

Complete information and prices may be obtained by writing direct to the manufacturer.

LANGEVIN AMPLIFIERS

West 65th Street, New York, has just announced a series of amplifiers known as the 101 Types. These amplifiers are designed for commercial continuous service, and meet the need for medium gain, high power bridging amplifiers. Where increased power is desired any number may be bridged across busses from 1 to 1000 ohms. Therefore a complete amplification system of high quality and great flexibility is provided when used in conjunction with a program or line amplifier such as the Langevin 102 Series.

All models in this 101 series will deliver 50 watts to a nominal load impedance with less than 3% r-m-s harmonic distortion at 400 cycles. The gain control provides continuous adjustment over a 40 db range and bridging connections. Chassis are 16 gauge welded steel, zinc plated, and bonderized. Finish light gray baked enamel. Weight approximately 45 pounds.

ELECTRONIC COUNTER

The Potter Instrument Company at 136-56 Roosevelt Ave., Flushing, New York, announces a new two-decade electronic counter designed for industrial and laboratory uses.

The counter is actuated by a closing contact, sine wave, or pulse input, as from a photo-cell, at rates up to 1,000 cycles per second. Each decade divides by ten, giving a scaling factor of 100. The count for 0 to 99 appears on two banks of neon lamps.

A telephone-type relay is connected to the counter output and the contacts of this relay close once for each 100 input cycles. These contacts are connected to an output terminal. A conventional electro-mechanical counter may be connected to the output terminals to extend the count to as many places as desired.

An important application of the unit lies in counting rates exceeding 10 cycles a second, which are generally too fast for conventional counters; or in installations where a conventional counter wears out prematurely from high speed continuous operation or is unreliable. The electronic counter makes it possible to increase the counting rate 100 times.

Another use for the electronic counter is in counting and calibrating the actual number of cycles that resistance welding timers apply.

This unit can be used as an interval

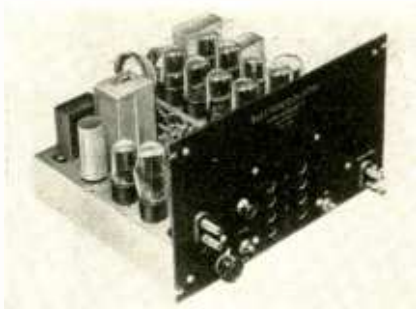

timer by connecting it through a switch to a known external frequency. When the switch is closed and opened, the unit will count the number of cycles of the known frequency that have passed in the closed-switched time interval, giving a reading in terms of the number of cycles of the known frequency. The 60 cycle line may be used as the known frequency.

The equipment is sturdy and intended for rigorous and long use. It uses a complement of 11 tubes. The counter can be supplied with switches to make it pre-determining. Operation is from a 60 cycle, 105 to 125 volt line. Weight of the Potter two-decade Electronic Counter is 25 pounds.

G-C INSTRUMENT KNOB

The General Cement Mfg. Co., of Rockford, Illinois announces the availability of a new type knob for communication equip-



ment, instruments, etc. It is constructed of smooth finished molded bakelite with pointer arrow on front. 1 3/4" O. D. x 7/8" over-all height. Write to manufacturer for complete knob and accessory information.

DU MONT OSCILLOGRAPH

What happens to a laboratory instrument when it goes to war is told in design changes and refinements effected during the past two years and currently incorporated in Du Mont Type 208B oscillograph now offered by Allen B. Du Mont Laboratories, Inc., Passaic, N. J.

An already popular instrument enjoying the widest popularity in laboratories and plants, the Du Mont Type 208B becomes a better, more rugged and most dependable oscillograph under the trying conditions of field service and rough handling, because of these wartime touches:

Use of mineral-oil-impregnated, hermetically-sealed, paper capacitors, as well as increased voltage ratings for certain paper capacitors, for greater factor of safety. Indeed, capacitors are operated at less than 80% of voltage rating, while all composition resistors operate at less than 40% of

power rating. High-voltage wire replaces previous standard wire in high-voltage circuits.

Various changes have been made in the tube complement. There is a change of negative supply rectifier from Type 17 to the Army-Navy preferred Type 6X5GT/G; from the 1/4 watt neon tube to the Army-Navy preferred Type 991 voltage regulator for greater stability; from Type 6F8G tubes to Army-Navy preferred Type 6SN7GT, with improved performance. There is now included a frequency range adjustment potentiometer in the time base as a factory adjustment, for accurate time-base frequency setting.

For greater mechanical ruggedness, there are several refinements such as the addition of mounting straps on capacitors subject to breakage in transit, and tube clamps for

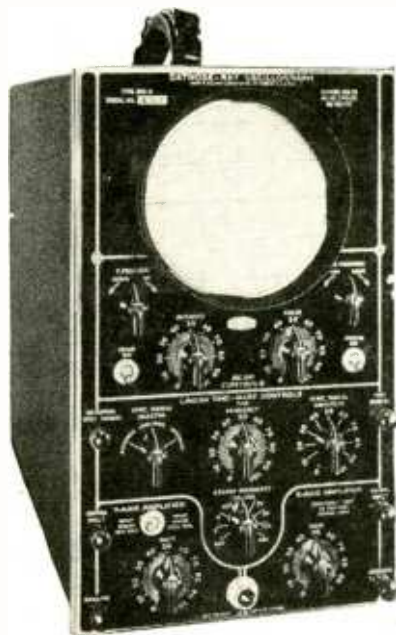

tubes subject to jars. A flange is added on the chassis assembly to provide extra strength against rough handling. Also better sockets, self-locking stop nuts, rolled bead on cathode-ray tube shield, additional brackets, and four bank supports to prevent breakage of banks during rough handling.

TRANSFORMERS

A new development in transformers with self-aligning, detachable mounting studs are now in production by the Electronic Components Company, 423 N. Western avenue, Los Angeles, Calif.

This novel and practical feature, according to Jack Durst, co-owner of the company, allows an actual tolerance in mounting dimension that can exceed one-quarter inch and eliminates rejects due to bad threads, leaks around studs, bent or broken studs or changes in length specifications.

A simple clip arrangement, stamped from heavy gauge steel, cadmium plated, prevents the stud from turning while it permits centering in two directions. The stud can be moved (not bent) in four directions to align with irregularly spaced holes and is replaceable in the field with any round head machine screw available.

Transformers equipped with this new Ecco mounting feature are available in 15 standard case sizes, either hermetically or non-hermetically sealed.

ELECTRONIC HEATING

A sixteen page booklet written for both engineer and manufacturer on the subject of electronic heating.

All the essential facts are discussed in a language stripped of confusing terminologies. It contains a brief record of the historical background and development of electronic heating—explains the principle of its operation—describes the two chief methods and fields of application and lists may prove present day uses. Many illustrations are used to make all the important parts of the text easily understood and several types of High Frequency Generators are shown.

This is an important handbook to have if you are considering the application of electronic heating to your own manufacturing methods. The booklet is available upon request by writing to Scientific Electric, 107-119 Monroe Street, Garfield, New Jersey.

TEST EQUIPMENT CATALOG

A new bulletin F issued by the Shallcross Manufacturing Company, Collingdale, Penna. describes several forms of High-Voltage Test Equipment. These include Portable Kilovolt-meters suitable for use from 1 to 30 kilovolts as well as the well known Shallcross Corona Protected Kilovoltmeters for measurements up to 200 kilovolts. Separate Kilovolt-meter Multipliers are available for use with external meters for measurements from 1 to 30 kilovolts; Corona protected resistors are available separately for use with suitable meters to permit measurements of potentials up to 200 kilovolts.

A copy of the new bulletin F will be gladly sent upon request to manufacturer.

CML STROBOSCOPE

Based on a completely new principle, the recently developed CML Model 1200 Stroboscope increases the range through which moving objects may be examined. Now rotary speeds from 600 to 600,000 R.P.M. or vibrations from 10 to 10,000 C.P.S., can be "stopped" and studied.

Since the light source is mounted in a



small probe at the end of a 5-foot flexible cable, small objects may be easily viewed at close range. Provision is made to operate the unit from external tuning fork or crystal standards, where extreme accuracy is required. The motion of objects moving at irregular speeds may also be "stopped" with the Model 1200.

An accurate repetitive pulse rate is ob-

tained, as the pulses are derived from a stable audio oscillator.

Not only does this eliminate the necessity for constant readjustment of the repetitive rate, but it also insures clearly defined images at high speeds.

A light intensity control switch is also provided for greater flexibility. This enables the user to control both the intensity of the light and the duration of the pulse length.

Descriptive bulletin available from the maker, Communication Measurements Laboratory, 120-24 Greenwich Street, New York.

CONDENSER MOUNTING

The new M type brackets pictured above have been specially developed to withstand the most severe vibration conditions encountered by all branches of the armed forces. They meet all Army, Navy and Aircraft specifications.

Designed to permit the mounting of oil capacitors in either vertical or inverted position, they are readily adapted to any industrial application.

This is an exclusive development of Industrial Condenser Corporation, manufacturers of a complete line of Oil-filled, Electrolytic, Wax and Special Mica Capacitors for every industrial, communications and signalling application up to 250,000 volts working.

Industrial Condenser Corporation has recently removed into a larger plant at 3243-65 North California Avenue, Chicago 18, Illinois.

ELECTRONIC OSCILLOGRAPH

For aircraft engine manufacturers, electric power companies and research laboratories, a new self-contained industrial electronic oscillograph which records characteristics of electrical phenomena lasting as little as a fraction of a millionth of a second is announced by Westinghouse Electric and Manufacturing Company.

An instrument of the cold cathode type, the electronic oscillograph is capable of recording single electrical transients with respect to time, or two electrical phenomena with respect to each other, such as voltage versus current, in the form of diagrams produced by two pairs of electrostatic deflecting plates disposed at right angles to one another. The cathode of the tubes is energized from a 50 kv d-c rectifier with a control to correct for line voltage variation. The beam is normally blocked by a target. An impulse synchronized with the phenomena will trip the relay which bends the beam around the target so that it will strike the fluorescent screen or film below.

The new streamlined unit consists of the oscillograph proper in front of the cabinet and the cabinet proper which houses all energizing and control circuits. Energizing terminals are enclosed except one bushing connected to the source of synchronizing impulse. Concentrating coils, beam current meter, and leak valve, control the intensity and size of the trace on the film. Deflecting coils move the zero position of the beam so as to use the whole area of the exposed film for the record.

In addition to the fluorescent screen for direct observation, the instrument contains a stationary film holder taking a standard film for recording electrical phenomena lasting 1/1000 of a second or less, and may be operated with a rotating film drum for phenomena lasting from 1/1000 to 1/10 of a second. A photoelectric control which makes it possible to take an oscillogram in one revolution of the drum, regardless of speed, eliminates the possibility of superimposed waves.

Further information on the electronic oscillograph may be secured from P. O. Box 868, Westinghouse Electric and Manufacturing Company, Pittsburgh 30, Pa.

W-J PORTABLE AMPLIFIER

Walker-Jimieson, Radio and Electronic distributors at 311 South Western Avenue in Chicago, have started production on a new amplifier unit. This 30-watt amplifier operates on 110 volts, 60-cycles. Its two mike inputs and one phono input



make it useful in the vast majority of applications. Output impedances of 4, 6, 8, and 500 ohms may be selected at will. Frequency response is 50-10,000 cycles. The record gain is 69 db and the mike gain 116 db. Tubes employed are 3-6SJ7, 2-616, 6N7 and an 83. The amplifier is housed in a gray wrinkle finished steel cabinet, 17" x 10½" x 19½".

The manufacturer will be pleased to furnish further information.

COMAR CIRCULAR

A new, two color, four page circular has recently been issued by Comar Electric Company of Chicago.

It describes Comar Relays, Switches, Condensers, Coils and other products, and accents ability to design and produce special electrical and electronic devices.

A copy may be obtained free by writing Comar Electric Company, 2701 Belmont Avenue, Chicago 18, Illinois.

LANGEVIN SPEAKER

A new loudspeaker, Type 26-B, designed to operate with maximum intelligibility through high noise levels and with uniform distribution over horizontal angles of 120 and vertical of 40, has been announced by the Langevin Company. It is designed for voice reproduction when used by itself or as an excellent high frequency component to a wide range system.

The unit is one cast aluminum, equipped with heavy universal mounting brackets, and is designed for economy of installation. It handles power input of 40 watts when equipped with 2 Jensen U-20 drive units. 22" wide, 14½" deep, 20" high. Complete technical bulletin upon request. The Langevin Company, 37 W. 65th St., New York 23.

ANTENNA PROBLEM

Faced with a difficult antenna problem, E. H. Andresen, Chief Engineer of WBEZ, called on Andrew engineers for a solution. The problem was that of coupling a 70 ohm unbalanced coaxial transmission line to the much smaller balanced impedance of the antenna. Uncertainty of the exact value of the antenna impedance made the problem difficult, and called for some kind of an adjustable coupling device.

The problem was solved by constructing a quarter wave impedance transforming section with a concentric "bazooka" for the balance conversion. Adjustments were made by varying the average dielectric constant in the resonant section.

FOOT SWITCH

General Control Company, 1200 Soldiers Field Road, Boston 34, Mass., announces a new foot switch for actuating one to eight circuits. Designated the Model "MF", this is the flattest foot switch ever manufactured. The foot rest is only one-half inch above the floor, and it requires only 1/16th inch throw. This allows the operator to support his whole foot nearly at floor level, thereby reducing fatigue to a minimum.

The Model "MF" is ruggedly con-

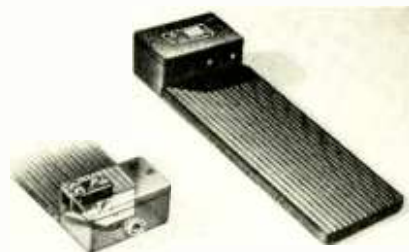

structed to withstand severe use. It is splash and dust proof so that factory conditions cannot affect its life or limit its applications.

VACUUM CAPACITOR

Designed to meet a wide range of specifications a new vacuum capacitor has been developed and put on the market by Industrial and Commercial Electronics, Belmont, California. Because of their compactness and stability, due to the utilization of vacuum as the dielectric, vacuum condensers are in wide usage. This is the first time a manufacturer has developed a capacitor meeting varying requirements of capacitances.

The new I.C.E. vacuum condenser is available with capacities ranging from 10

(Continued on page 78)

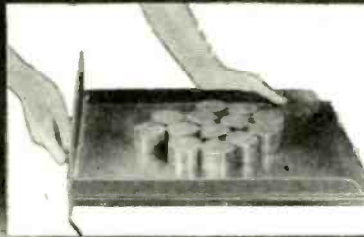

THERMEX meets the demand for high frequency equipment for pre-heating of plastic preforms. Preforms are placed on this drawer which slides into unit shown below.

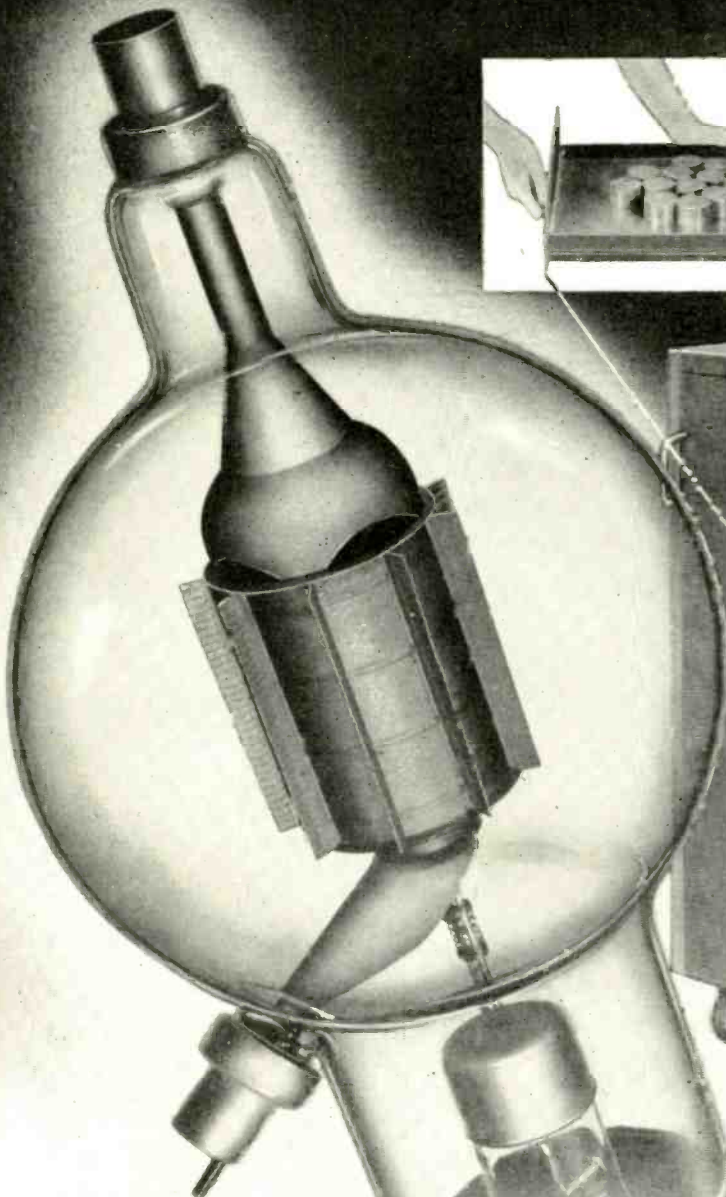

THERMEX MODEL 2-P

Of course it uses Eimac tubes

This compact Thermex unit measures 28 inches by 28 inches, stands 47 inches high, and weighs only 614 pounds. It is a practical and flexible piece of equipment with built-in heating cabinet and removable 12 inch by 15 inch drawer-electrode.

Being completely automatic, there is nothing to do but plug this Thermex in and load and unload the preform drawer. No dials, no tuning, not even a button to push. Closing the preform drawer all the way in, turns on the high frequency power and timer. At the end of the prescribed time, which may be anywhere from 5 to 10 seconds up to 2 minutes, the red indicating light goes out, the operator removes the tray and unloads the preforms into the mold cavities.

The Thermex Model No. 2-P, which is illustrated, operates at a frequency of 25 to 30 megacycles using 230 volt 60 cycle single phase current. It has an output in excess of 3400 BTUs per hour, and it uses a pair of Eimac 450-TH tubes. The use of electronic heating has increased production for many plastic manufacturers who

have been leaders in utilizing the science of electronics.

The Thermex Division of the Girdler Corporation of Louisville, Ky., is a leader in supplying equipment for this and other industrial applications. It's natural that Eimac tubes are used, since these tubes are first choice of leading electronic engineers throughout the world.

Follow the leaders to

Eimac
REG. U. S. PAT. OFF.
TUBES

EITEL-McCULLOUGH, Inc.

985 San Mateo Avenue, San Bruno, California

Plants located at: San Bruno, California and Salt Lake City, Utah

Export Agents: Frazer & Hansen, 301 Clay St., San Francisco 11, California, U. S. A.

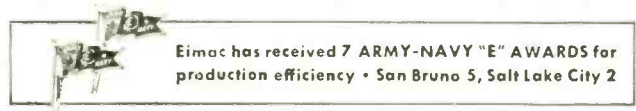

Eimac has received 7 ARMY-NAVY "E" AWARDS for production efficiency • San Bruno 5, Salt Lake City 2

TRANSMITTER

[Continued from page 34]

caps may then be replaced on the low-voltage rectifiers and r-f stages and plate switch again closed. Tank capacitors should be resonated starting from the maximum capacity position to avoid tuning to a harmonic frequency. The capacitor is then adjusted to minimum plate current indication. However, due to slight differences in the Q of the circuits, minimum plate current and maximum grid current to the following

stage is not always the same even in commercially designed transmitters. When this occurs, maximum efficiency results when the capacitor is adjusted for maximum grid drive to the following stage. This procedure of tuning is followed through to the final stage.

Where neutralizing is required, and accomplished by a capacitor, the neutralizing capacity is adjusted for minimum or zero grid current on the following stage. The neutralizing capacity for high power output stages is usually fixed, but neutralizing adjustments should be checked after the entire transmitter is in operation by removing the crystal from the oscillator circuit and

observing all grid and tank circuit meters. These currents should be zero, and this is especially important for the final stage.

Inductive and Capacitive Tuning

Since inductive tuning for high power stages has become almost universal in recent years, it is interesting to note the differences existing between tuning procedure for variable inductance and variable capacitance.

In Fig. 4, if the current in the inductive branch of the parallel circuit is set at I_L and the capacity is adjusted so that the capacitive current is I_c then the external current is in phase with the voltage and unity power factor exists as indicated by $0-0'$. Now assume that the capacity is the variable factor, and this capacity is decreased so that the current is I_c'' , then the resulting current will be I'' , or greater than at unity power resonance condition. It is obvious from this vector that when the capacity is the variable factor, the condition for unity power factor and minimum current are satisfied by the same setting of the capacitor.

If the inductance is made variable, we must set up a set of vectors as shown in Fig. 5, where the upper part of the circle whose center is O' traces the current in the capacitive branch and the lower part traces the inductive branch current. Now if the capacity is of fixed value, the capacitive current will be fixed at I_c . As the inductance is varied so that the inductive current passes through I_{L1} , I_{L2} , and I_{L3} , this vector addition with I_c will cause the external current to pass through values I_1 , I_2 , I_3 , and I_{min} along the projected semi-circle whose center is P .

Thus it is obvious that when a tank circuit is tuned by means of a variable inductor, maximum power transfer to a coupled stage will not occur at the point of minimum current indication. This does not mean that the stage must be detuned, but simply that the circuit is adjusted from minimum current resonance condition to the unity power factor resonance condition. Under practical operation, it is simply necessary to tune through minimum current indication position to the proper side of this point where maximum power transfer is indicated in the coupled circuit.

HAMS KEEP 10-METER BAND

While a press release from a source other than the FCC did not mention that amateurs are slated to keep their 28-30 mc band, the official FCC report shows that it is included in the proposed frequency allocations. We regret that we went to press before receiving this information and therefore omitted it from our list.

Ingenious New Technical Methods

Presented in the hope that they will prove interesting and useful to you.



New Quick-set Dial Drill Sharpener Eliminates Guesswork...Keeps 'em Drilling Faster—Longer

Attached to the Drill Sharpener, it adjusts drill edges to the proper angle for precision grinding, putting drill sharpening on a quick, efficient basis.

QUICK-SET DIAL easily and accurately adjusts Sharpener for sharpening drill from 5/32" to 1" sizes. Dial insures accuracy in measuring angles and clearances on twist drills, preventing trouble and making drills last longer. Dial-Set sharpened drills cut faster and more accurately, as the edges are alike and uniformly sharpened.

Precision built, calibrated and tested, unit is easy to set up and operate. Saves wear and tear on drill presses—prolongs drill life—cuts costs—improves quality—speeds output.

Another thing worth remembering is Wrigley's Spearmint Gum. That familiar red, white and green package which always meant "a help on your job." No more of this famous brand and flavor is being made for anyone now—even for the Armed Forces overseas—as Wrigley's stockpile of finest quality raw materials is all used up. But—remember Wrigley's Spearmint—The Flavor Lasts.

You can get complete information from Ameraco Industrial Specialties, 122 S. Michigan Ave., Chicago 3, Ill.

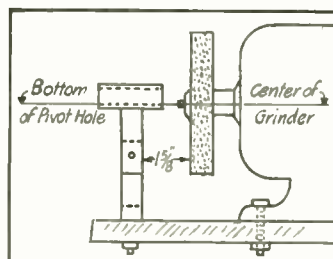

Front view of grinder

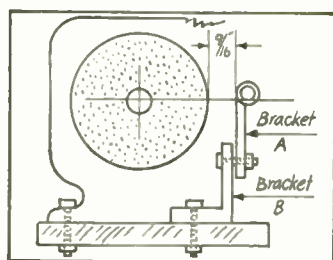

Side view of grinder

Z-59

RADIO BIBLIOGRAPHY

F. X. RETTENMEYER

RCA Victor Division, Radio Corporation of America

17—AIRCRAFT RADIO, PART 7

- Airplane Radio Sets Send and Receive—*Wireless Age*—Vol. 9, April 1922, Page 39.
- Radiophone on Mail Planes—*Aviation*—Vol. 12, May 1, 1922, Page 516.
- Emergency Radio Equipment for Airplanes—G. H. Daly—*Wireless Age*—Vol. 9, May 1922, Page 61.
- New Radio Sets for Service Airplanes—*Aviation*—Vol. 12, June 26, 1922, Page 759.
- The Magnavox Anti-noise Airplane Telephone—E. S. Pridham and P. L. Jensen—*Telephone Engineer*—Vol. 23, Jan. 1921, Page 36.
- Aircraft Wireless Apparatus—F. Bracy and H. Oliver—*Radio Review*—Vol. 2, Feb. 1921, Page 104.
- Aircraft Wireless Apparatus—J. Bethenod—*Radio Review*—Vol. 2, Feb. 1921, Page 103.
- Pruebas de Radiotelefonía—*Revista Telegrafica*—Vol. 9, Feb. 1921, Page 30.
- Radio Aboard Airplane—*Scientific American*—Vol. 125, Sept. 3, 1921, Page 159.
- Flying Boat Radio Transmitter—J. Marsten—*Radio News*—Vol. 3, Sept. 1921, Page 185.
- British Air Fleet Equipped with Radiophone—*Wireless Age*—Vol. 9, Dec. 1921, Page 16.
- Apparatus for Modulation of High Frequency Oscillations—Tonsender—*Jahrb. D. Drahtl. Telegraphie*—Feb. 1920, Page 159.
- Radio Review—Vol. 1, August 1920, Page 553.
- A Light Weight Airplane Transmitter—*Everyday Engineering Mag.*—Vol. 8, Jan. 1920, Page 228—*Radio Review*—Vol. 1, August 1920, Page 568.
- Navy Improves Air Transmitter Equipment—*Aerial Age Weekly*—Vol. 14, Oct. 4, 1920, Page 115.
- The Provision of Side Tone and Intercommunication on Wireless Telephone Sets for Aircraft—*Wireless World*—Vol. 8, October 16, 1920, Page 509.
- Wireless on Air Mail Machines—Maj. Gen. Sir F. H. Sykes—*Aeronautics*—Vol. 19, Oct. 21, 1920, Page 298.
- Wireless Transmitting and Receiving Apparatus for Use on Aircraft—L. A. McDougald and M. Pountz—*The Engineer*—Vol. 130, Oct. 29, 1920, Page 442.
- Swivelling Brackets for Mounting Electric Generators on Aircraft—F. J. Hooper—*Radio Review*—Vol. 1, Nov. 1920, Page 733.
- A Broadcast Frequency Measuring Set—W. M. Kellogg—*Bell Lab. Record*, 1936, page 307.
- Radio on Germany's Latest Floating Island (Transatlantic Aircraft Depot Ship "Ostmark")—*Wireless World*, Vol. 39, July 31, 1936, page 99.
- Notes on Piezoelectric Quartz Crystals—Isaac Koga—*I.R.E. Proc.*—March 1936, page 510.
- Young's Modulus of a Crystal in Any Direction—Isaac Koga—*I.R.E. Proc.*—March 1936, page 532.
- A Determination of Some of the Properties of Piezo Electric Quartz Resonator—Karl S. Van Dyke—*I.R.E. Proc.*—April 1935, page 386.
- An Electrochemical Representation of a Piezoelectric Crystal Used as a Transducer—W. P. Mason—*I.R.E. Proc.*—April 1935, page 1252.
- Quartz Crystal Filters—W. P. Mason—*Bell Lab. Record*—June 1935, page 305.
- Proper Frequencies of Piezoelectric Quartz Crystals Excited in the Direction of Thickness—L. Bergman—*Annalen Der Physik*—Jan. 1935, page 553.
- Anomalous Dispersion of the Dielectric Constant of Rochelle Salt—G. Busch—*Helv. Phys. Acta*, May 1935, page 31.
- Method of Testing Crystals for Piezoelectricity—L. Bergman—*Phys. Zeits.*—January 1935, page 31.
- Motion of a Bar Vibrating in Flexure—W. P. Mason—*Acoustical Soc. Am. Journal*, April 1935, page 246.
- The National Primary Standard of Radio Frequency—E. L. Hall, V. E. Heaton and E. G. Lapham—*U. S. Bureau of Standards Journal*—Feb. 1935, page 85.
- 19A Transmitter for Private Airplanes—B. S. Blair—*Bell Lab. Record*—Dec. 1935, page 136.
- Wend from Quartz Crystals—S. C. Hight—*Bell Lab. Record*, December, 1935, page 121.
- Temperature Coefficients of Piezoelectric Quartz Plates and Rods—R. Bechmann—*Hochfrequenztechn. u. Elektroakustik*—Nov. 1934, page 145.
- Optical Proof of Super Harmonics and of Oscillating Characteristics of Piezoquartz According to Debye and Sears Method and its Application for the Determination of Electric Wave Lengths—L. Bergmann—*Hochfrequenztechn. u. Elektroakustik*—March 1934, page 83.
- A 200-Kilocycle Piezo Oscillator (abstract)—E. G. Lapham—*I.R.E. Proc.*—January 1934, page 38.
- Development of Standard Frequency Transmitting Sets (abstract)—L. Mickey and A. D. Martin—*I.R.E. Proc.*—February 1934, page 265.
- Quartz Crystal Controlled Oscillator Circuits—Harry R. Meahl—*I.R.E. Proc.*—June 1934, page 732.
- Thermal Characteristics of Piezoelectric Quartz Plates—I. Koga—*Radio Research*—July 1934, page 61.
- Measurement of a Strain Ratio in an X-cut Quartz Crystal—M. Y. Colby and S.

[Continued on page 66]



Shaft Couplings

A link between control and variable circuit element, shaft coupling design can be an important factor in proper functioning of electronic equipment.

Illustrated are but three of many Johnson insulated shaft couplings; among them units providing a high degree of flexibility but freedom from backlash common to others resembling them; rigid types where accurate shaft alignment is required and torque may be high; bar types for high voltages or very high frequencies. All are characterized by best steatite insulation properly proportioned for electrical and mechanical strength, by accurate metal parts finished to stand salt spray test, and by those little evidences of Johnson engineering and manufacturing skill that are most appreciated only after use and comparison.

Ask for catalog 968(K)



JOHNSON
a famous name in Radio

F. F. Johnson Co. Waseca, Minn.

RECEIVER

(Continued from page 39)

sults are plotted as shown in Fig. 29 with the r-f input in microvolts as abscissas on a logarithmic scale and the power output as ordinates on a linear scale for voltage.

The second curve shows the maxi-

Total harmonic distortion is measured at each point as shown in Fig. 30.

Conclusion

This completes the usual measurements made on a receiver. Other tests may be required, but the above outline will be found adequate in most cases; special designs or circumstances, however, may make it necessary to perform additional tests which can be devised as

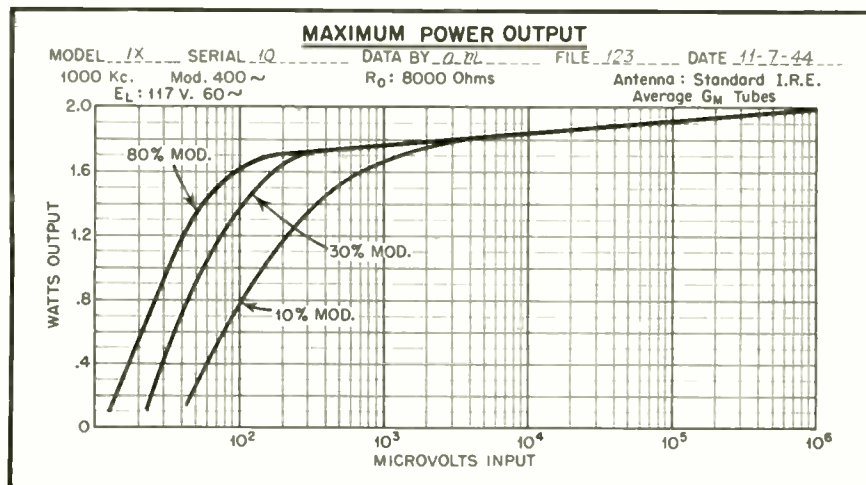

Fig. 29. Typical power output curves for various modulation percentages

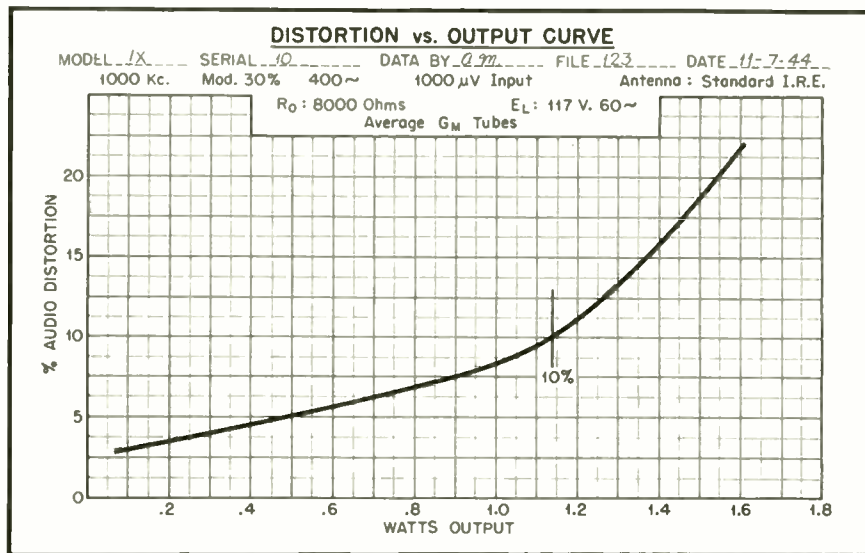

Fig. 30. Method of plotting distortion vs. power output

mum output of the receiver at a given percentage of harmonic distortion and is measured with a signal input of 1000 microvolts modulated 30% at 400 cycles. The volume control is adjusted to obtain various outputs from a minimum of 50 milliwatts to full output.

the necessity arises. The data should be tabulated and plotted as shown in the various tables and figures. Combination AM-FM receivers are usually considered as two separate receivers for measurement purposes and their data and curves plotted separately.

Reference

- Ballantine & Snow, "Reduction of Distortion and Cross-Talk in Radio Receivers . . ." IRE Proc. Dec. 1930.

[Conclusion]

CL
★ LAPEL ★
Crystal Microphone

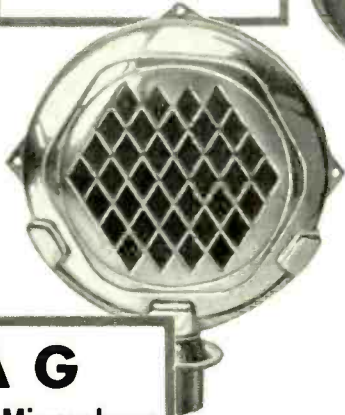

AG
Crystal Microphone
Public Address



C6
Crystal Microphone
Public Address



C7
Crystal Microphone
Public Address

RC
Home Recorder
Crystal Microphone



THINK American

when you begin to utilize the conversions of military perfected voice transmission and electronic circuits that will be prevalent in the immediate post war period. Check the advantage of American Microphone quality. It is discernable . . . it always is.

JOBBERS
Get your name on the list now, to receive important announcements American will make when the war time job is done.

American MICROPHONE CO.
1915 So. Western Avenue, Los Angeles 7, California

S

IGMA SENSITIVE DOUBLE COIL RELAYS

... open new possibilities
in circuit functions

Energized from separate sources, coils may be connected to produce aiding or opposing forces according to functional requirements.

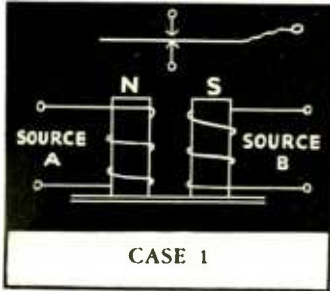

IN CASE 1, above, sources A & B may supply insufficient power to operate the relay separately, but simultaneous currents cause the relay to operate.

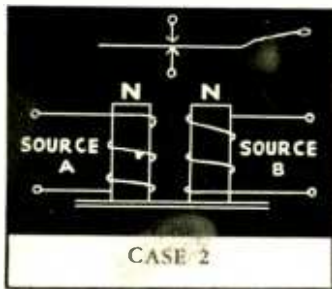

IN CASE 2 equal inputs from sources A & B create opposing forces which balance and prevent operation. However, a differential current of only a few milliwatts will cause positive relay action. Each coil may be drawing power up to many times that required to operate the relay without seriously affecting its sensitivity to the differential current. Sigma Series 5 relays are regularly furnished with two coil terminals on a 5-pin base. When three or four coil terminals are needed this arrangement can be furnished in the F type without cover or base or in the R type with rectangular cover and molded base carrying terminal lugs and mounting ears. This permits mounting above deck and wiring below deck.

In ordering relays for special applications, be sure to specify full operating characteristics, describing circuit details and surrounding conditions as fully as possible.

Our varied experience will help you choose the right relay for YOUR job.



Sigma Instruments, Inc.
Sensitive RELAYS

66 Ceylon St., Boston 21, Mass.

BIBLIOGRAPHY

[Continued from page 63]

Harris—*Optical Soc. of America Journal*—August 1934, page 217.

Interferometer Method of Measuring the Amplitude of Vibration of Quartz Bar Crystals—S. H. Cortez—*Optical Soc. of Am. Jnl.*—May 1934, Erratum (July).

Electrical Filters Employing Quartz Crystals as Elements—W. P. Mason—*Bell System Technical Journal*—July 1934, page 405.

Some Improvements in Quartz Crystal Circuit Elements—F. R. Lack, G. W. Williard and I. E. Fair—*Bell System Technical Journal*, July 1934, page 543.

Modes of Vibration of Piezoelectric Quartz Plates—Y. Sakisaka and I. Sumato—*Inst. Phys. and Chemical Research*, October 1934, page 20.

Temperature Coefficient of Quartz Oscillators—H. Straubel—*Zeits. F. Techn. Physik*—Dec. 1934, page 607.

Piezoelectric Microphones—A. L. Williams—*Jrnl. of Soc. of Motion Picture Engineers*, 1934.

Quartz Crystal Fundamentals—J. J. Wolfskill—*QST*—December 1934, page 37.

Refracting Interferometer for Examining Modes of Vibration of Quartz Plates—H. Osterburg—*Review of Scientific Instruments*—May 1934, page 183.

Circle Diagrams of Quartz Crystals (with English abstract)—R. Usul—*Inst. Elec. Eng.*—Japan, Journal, March, 1934, page 201.

Triple Interferometer for Distinguishing Flexural and Longitudinal Vibrations in Quartz—H. Osterberg—*Optical Soc. of Am. Journal*—Jan. 1933, page 30.

A 200 Kilocycle Piezo Oscillator—E. G. Lapham—*U. S. Bureau of Standards Jrnl*—July 1933, page 59.

Converse Piezoelectric Effect in Mixed Crystals Isomorphous with Rochelle Salt S. Blumenthal—*Physics*—May 1933, page 172.

Piezoelectric Properties of Tourmaline—W. Fox and M. Underwood—*Physics*—January 1933, page 10.

The Interdependence of Frequency Variation and Harmonic Content, and the Problem of Constant-Frequency Oscillators—Janusz Groszkowski—*I.R.E. Proc.*—July 1933, page 958.

Modes of Vibration of Piezo-Electric Crystals—N. H. Williams—*I.R.E. Proc.*—July 1933, page 990.

A Piezo-Electric Loudspeaker for the Higher Audio Frequencies—Stuart—*Bal-lantine—I.R.E. Proc.*—October 1933, page 1399.

Vibrating Quartz Crystals and their Sound Emission—K. Bucks and H. Muller—*Zeit für Hochfrequenztechnik*—July 1933, page 75.

Notes on Crystals—E. H. Reitzke—*Radio Engineering*—Sept. 1933, page 23.

The Application of Methods of Geometrical Inversion to the Solution of Certain Problems in Electrical Resonance—W. G. Cady—*Proc. of the Am. Academy of Arts and Sciences*, Vol. 68, No. 10, Sept. 1933.

Pierce Crystal Oscillations—K. Heegner—*Electrische Nachrichten-Technik*—Sept. 1933, page 357.

New Temperature Control Quartz Oscillators—R. Rechman—*Electrische Nachrichten-Technik*—Sept. 1933, page 371.

Tourmaline Oscillators—S. Matsumura and S. Ishikawa—*Radio Research*—June 1933, page 1.

Thickness Vibrations of Piezoelectric Oscillating Crystals—Isaac Koga—*Physics*—August 1932, page 70.

Piezoelectric and Dielectric Characteristics of Rochelle Salt—Von Erich Schwartz—*Electrische Nachrichten-Technik*—Dec. 1932, page 481.

Notes on Frequency Stability of Quartz Plates—L. B. Hallman, Jr.—*Radio Engineering*—February 1932, page 15.

Some Experimental Studies of the Vibrations of Quartz Plates—R. B. Wright and D. M. Stuart (abstract)—*I.R.E. Proc.*—Feb. 1932, page 182.

Quartz Plate Mountings and Temperature Control for Piezo Oscillators—Vincent E. Heaton and E. G. Lapham—*I.R.E. Proc.*—February 1932, page 261.

Application of Quartz Plates to Radio Transmitters—O. M. Hovgaard—*I.R.E. Proc.*—May 1932, page 767.

The Vibrations of Quartz Plates—R. C. Colwell—*I.R.E. Proc.* May 1932, page 808.

The Precision Frequency Measuring System of RCA Communications, Inc.—H. O. Peterson and A. M. Braaten—*I.R.E. Proc.*—June 1932, page 941.

Thickness Vibration of Piezoelectric Oscillating Crystals—I. Koga—*Radio Research*—Sept. 1932, page 157.

Recent Developments in Precision Frequency Control—D. E. Replogle—*Radio Engineering*—April 1932, page 29.

Temperature Variation of the Frequency

[Continued on page 68]

ALDEN

for Graphic Recording of any kind



OUR YEARS OF EXPERIENCE, and cumulative skills, in the designing and production of RADIO COMPONENTS, are now being used in making equipment which covers *the entire field of FACSIMILE*.

Actual service, as found in war and communication work under all conditions, has given a PRACTICAL quality to our equipment which, under ordinary conditions, would not have been obtained in years of engineering with limited application.

ALDEN PRODUCTS COMPANY is manufacturing practically ALL TYPES AND SIZES of facsimile and impulse recording equipment — using all the varied recording mediums: Photographic Paper, Film, Electrolytic Paper, Teledeltos, and Ink.

ALFAX IMPULSE RECORDING PAPER

By "COVERING THE ENTIRE FIELD," we mean . . .

1. Some of our equipment has been used for the transmitting and receiving of photographic pictures of reasonably high resolution (such as the war pictures now appearing in the news).
2. Continuous Recorders—of the type whose value has been proven on National and International news service circuits—are now on their way to the Orient, to be used for the receiving of the so-called "picture" languages. They use ALFAX paper.
3. Also, through the use of ALFAX (the first high-speed black and white permanent recording paper), HIGH-SPEED Signal Analysis Equipment has been made possible for various laboratories and Government Departments. Other equipments have employed Teledeltos Paper for message work and other purposes.
4. For outlying posts, where servicing equipment is an impossibility, or, where radio or wire links are of poor quality and power, ALDEN Tape Recorders (recording medium, ink)—have been designed to operate with a minimum of trouble and adjustments, and have PROVED MOST SATISFACTORY.
5. The ability of ALFAX Paper and ALDEN Machines to record impulses as they occur, without the inertia problems of many previous methods, has made possible other recorders at various speeds (including slow). They will record a whole day's history of related phenomena, with time indicated, and often—with self-calibrated linear reference marks for ready interpretation.

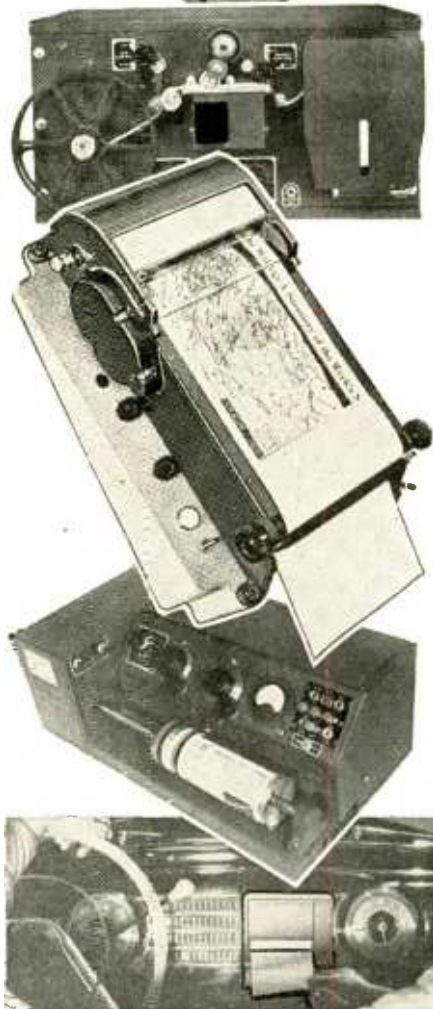

ALDEN PRODUCTS COMPANY

117 North Main Street

BROCKTON (64H) MASSACHUSETTS

Immediate Shipment!

RADIO PARTS and ELECTRONIC EQUIPMENT

from CONCORD

Our shelves are loaded with top-quality merchandise, dependable brands, complete assortments. Order them from CONCORD, by mail, by wire, by telephone. Our radio technicians are prepared to work with you and expedite special requirements. Tell us what you need. Two huge shipping warehouses, in CHICAGO and ATLANTA, ready to fill your orders and ship to you at once.

Typical Values Available NOW!

Cornell-Dubilier type
TJL6040, 4 mfd. 600
volt DC wkg. oil filled
condenser.

SB3015
Specially priced, \$1.49



Full Wave Vibrator
Transformer, 6 Volts.
Input—250 Volts.
60 MA. Output C.T.
SB5000
Specially priced, 79¢

I. R. C. type CS Dual
Potentiometer
2500 ohm and 25 ohm.
SB2007
Specially priced, 49¢



FREE! 64-Page "Book of Values"

Ready about April 1st—big 64-page "Book of Values" offering thousands of hard-to-get parts at substantial savings. Includes new 1945 Revised Listings of standard lines of Condensers, Resistors, Transformers, Test Equipment, and other essential radio parts.

CONCORD RADIO CORPORATION

Lafayette Radio Corporation

901 W. Jackson Blvd. 245 Peachtree Street
CHICAGO 7, ILL. ATLANTA 3, GA.

CONCORD RADIO CORPORATION
901 W. Jackson Blvd., Dept. F-35
Chicago 7, Illinois

Please send me a FREE copy of the "Book of Values" of radio and electronic parts and equipment as soon as it's off the press.

Name.....
Address.....
City..... State.....

BIBLIOGRAPHY

[Continued from page 66]

of Piezoelectric Oscillations of Quartz—R. E. Gibbs and V. N. Thatte—*Philosophical Magazine*—October 1932, page 682.

Modes of Vibration of Quartz Piezoelectric Plates as Revealed by an Interferometer—W. D. Dye—*Royal Soc. Proc.*—October 1932, page 1.

Experimental Determination of the First Piezoelectric Modulus of Quartz—Berta Nussbaumer—*Zeit. für Hochfrequenztechnik*—October 1932, page 781.

First Piezoelectric Modulus of Quartz from Determinations with a Quartz Resonator—Angela Szekely—*Zeit. für Hochfrequenztechnik*—October 1932, page 560.

Fundamental Crystal Control for Ultra High Frequencies—Harold Strubel—*QST*—April 1932, page 10.

Piezoelectric Loudspeakers and Microphones—A. L. Williams—*Electronics*—1932, page 166.

Interferometer Method of Studying Vibrations of Oscillating Quartz Plate—H. Osterberg—*Optical Soc. of America Journal*—January 1932, page 19.

Quartz Crystal Resonators—W. A.arrison—*Bell Lab. Record*—February 1932, page 194.

Discussion on "Quartz Plate Mountings and Temperature Control for Piezo Oscillators"—Vincent E. Heaton and E. G. Lapham—*I.R.E. Proc.*—February 1932, page 1064.

Crystal Control Applied to the Dynatron Oscillator—K. A. MacKinnon—*I.R.E. Proc.*—November 1932, page 1689.

Twenty-five Mile Radiophone Transmitter Using Marconi VT's for 200 Meters—C. R. Leutz—*Wireless Age*—Vol. 7, April 1920, page 15.

Duplex Wireless Telephony—Some Experiments on Its Application to Aircraft—P. P. Eckersley—*Radio Review*—Vol. 1, April 1920, page 338.

Wireless Telephone Transmitter for Seaplanes—*Electrician*—Vol. 85, July 30, 1920, page 133.

Appareil Électrique pour Aéronefs—P. Mauer—*L'Électricien*—Vol. 35, Dec. 1920, page 265—*Radio Review*—Vol. 1, July 1920, page 514.

Aircraft Wireless Telephone Apparatus—*Wireless World*—Vol. 8, August 7, 1920, page 356.

Flying Over Clouds in Relation to Com-

mercial Aeronautics—M. Jones—*Aeronautical Journal*—Vol. 24, May 1920, page 220—*Radio Review*—Vol. 1, August 1920, page 571.

Radio Apparatus for Aircraft and Ground Stations—E. M. Kenney—*Electrical World*—Vol. 73, May 24, 1919, page 1131—*Proc. Eng. Soc. Western Penn.*, Vol. 36, February 1920, page 1,

Thermionic Valves on Aircraft—R. Whidington—*Nature*—104, Feb. 12, 1920, page 630—*Radio Review*—Vol. 1, August 1920, page 559.

Duplex Wireless Telephony—Some experiments on its application to aircraft—P. P. Eckersley—*Radio Review*—Vol. 1, April 1920, page 338.

Wireless Sets on NC Seaplanes—*Aircraft Journal*—May 31, 1919.

Development of Airplane Radio Telephone Set—H. M. Stoller—*Electric Journal*—Vol. 16, May 1919, page 211.

Aircraft Wireless Sets—The Sterling Transmitter—J. J. Honan—*Wireless World*—Vol. 7, May 1919, page 101.

Aircraft Transmitting Equipment Type SE 1310—*Aviation*—June 1, 1919.

Power for Aeroplane Wireless—Capt. G. F. Gray—Lt. J. W. Reed and I. N. Elderkin—*Aeronautics*—Vol. 17, July 3, 1919, page 25.

Wireless Apparatus of the Allies—*Aeronautics*—Vol. 17, July 3, 1919, page 18.

Aircraft Transmitting Equipment Type SE 1310—*Aeronautics*—Vol. 17, July 17, 1919, page 69.

Aircraft Wireless Sets—*Wireless World*—Vol. 7, July 1919, page 216.

A Seaplane Wireless Transmitting Set—*Electrical Review*—Vol. 85, August 23, 1919, page 233.

Air Fans for Driving Electric Generators on Airplanes—Capt. G. F. Gray, Lt. J. W. Reed and I. N. Elderkin—*Franklin Inst. Jnl.*—Vol. 188, August, 1919, page 270.

R34's Atlantic Wireless—*Aeronautics*—Vol. 17, Sept. 4, 1919, page 234.

Aircraft Telephony—B. Cohen—*Electrical Review*—Vol. 85, Nov. 7, 1919, page 603.

Aircraft Wireless Sets—Spark Transmitters—J. J. Honan—*Wireless World*—Vol. 7, Sept. 1919, page 341, Oct. 1919, page 410 and Nov. 1919, page 470.

Aircraft Wireless Section—The 54A—J. J. Honan—*Wireless World*—Vol. 7, 1919, page 512.

Die Entwicklung der Luftschiffstationen—
[Continued on page 70]



FIRST THIS - in 1930 *

98 ounces



THEN THIS - in 1940 *

21 ounces



NOW - in 1945 *

4.64 ounces

ALNICO 5

by Jensen

FIFTEEN YEARS AGO, when JENSEN introduced the first Permanent Magnet Loud Speaker in the United States, the magnet itself weighed 98 ounces (6.1 pounds)—a bulky, costly structure . . . but, still an outstanding first by JENSEN. ¶ By 1940, through advanced design and without decreasing the magnetic strength, JENSEN had reduced the weight of the magnet for an equivalent speaker to 21 ounces!

¶ Now, with **ALNICO 5** the most powerful magnet material ever developed, JENSEN is able to obtain the same magnetic strength as in the original 1930 design with a magnet weighing only 4.64 ounces, giving compactness and light weight with highest efficiency.



Jensen

SPEAKERS WITH

ALNICO 5

* All of equal performance ability

Specialists in Design and Manufacture of Acoustic Equipment

JENSEN RADIO MANUFACTURING COMPANY, 6601 SOUTH LARAMIE AVENUE, CHICAGO 38, ILLINOIS

RADIO

★ MARCH, 1945

69



for
**ULTRA-HIGH
FREQUENCY**
functions

● This Aerovox Type 1865 capacitor is designed for ultra-high-frequency radio power equipment such as television and FM transmitters. Especially recommended for fixed tuning, by-passing, blocking, coupling, neutralizing and antenna-series capacitance.

Losses are extremely low, due to highly refined sulphur dielectric used. Corona losses are avoided by the unique design, grounded case, and insulated terminal. Type 1865 (illustrated) has cast aluminum case; steatite insulator supports terminal. Lower-cost Type 1860 has aluminum can; mica disc insulator for terminal. Ratings up to 10,000 test volts effective. .00001 to .000125 mfd.



● Consult Us . . .

Our engineers can help you with your capacitance problems. Let us quote on your requirements.

AEROVOX
Capacitors
INDIVIDUALLY TESTED

AEROVOX CORP., NEW BEDFORD, MASS., U. S. A.
In Canada: AEROVOX CANADA LTD., HAMILTON, ONT.
Export: 13 E. 40 St., New York 16, N. Y. Cable: 'ARLAB'

BIBLIOGRAPHY

[Continued from page 68]

Tropitz—*Telefunken Zeitung*—Vol. 3, 1919, page 48.

Radio Transmitting Sets on the NC Type Seaplanes—*Electricity*—Vol. 31, 1919, page 505.

The Wireless Telephone in Air Service—*Electrical World*—Vol. 73, Feb. 1, 1919, page 239.

American Fliers Used Radio Telephones in Battle—*Popular Mechanics*—Vol. 31, Feb. 1919, page 195.

Phoning via Wireless from the Skies—Robert G. Skerrett—*Illustrated World*—Vol. 30, Feb. 1919, page 810.

Apparati Radiotelegrafici Tedeschi per Aeroplani—*L'Elettrotecnica*—Vol. 6, Feb. 5, 1919, page 81.

Funktelegraphie im Flugzeugen—E. Niemann—*Jahrb. D. Drahtlose-Telegraphic*—Vol. 14, page 69, May 1919, July 1919, page 190—*Electrical World*—Vol. 75, March 20, 1920, page 687—*Radio Review*—Vol. 1, August 1920, page 571.

Aeroplane Radiotelephone Apparatus—E. H. Felix—*Aerial Age Weekly*—Vol. 9, May 1919, page 397.

Radio Equipment of Naval Seaplanes—*Electrical World*—Vol. 73, March 24, 1919, page 1128.

Drahtlose Telegraphie and Flugzeugen—G. Eichhorn—*Jahrb. D. Drahtl. Telegraphic*—Vol. 12, August, 1917, page 195.

The DeForest Wireless Telephone—*Electrician*—Vol. 78, 1917, page 479.

Requirements for Radio on Airplanes—R. A. Fliess—*I.R.E. Proc.*—June 915, page 205.

Luftschiffahrt and Drahtlose Telegraphie Telefunken System—list of French and German Publications to 1912—*Jahrb. D. Drahtl. Telegraphic*—Vol. 6, July 1912, page 70.

La Télégraphie sans Fil en Aéroplane—*La Technique Aeronautique*—August 15, 1912—*La Lum. Elec.*—Vol. 19, Sept. 14, 1912, page 339.

Wireless Telegraphy From Aeroplanes—T. T. Baker—*Electrician*—Vol. 66, 1911, page 902.

La T. S. F. Abord des Dirigeables—*La Lumière Élec.*—Vol. 12, October 22, 1910, page 19.

Radio on Airships G. Ferris—*La Lum. Elec.*—Vol. 12, October 1910, page 99.

Constants of Fixed Antennas on Aircraft—G. L. Haller—*I. R. E. Proceedings*—Vol. 26, No. 4, April 1938, page 415.

Beacon Antenna Characteristics—H. K. Morgan—*Air Commerce Bulletin*—Vol. 9, No. 4, October 15, 1937, page 77.

Antennas for Air Navigation—D. G. Fink—*Electronics*—Vol. 9, Feb. 1936, page 34.

Auxiliary Aircraft Aerial Wound on Paper Cylinder and Shot Out of Spring Gun—*Communication and Broadcast Engineering*—Vol. 3, No. 8, August 1936, page 22.

Effective Resistance of Closed Antennas (Radio Beacon Loops)—V. I. Bashenoff and N. A. Myasoedoff—*I. R. E. Proc.*—Vol. 24, No. 5, May 1936, page 778.

New Procedure to Facilitate Investigation of Radio Range Trouble—*Air Commerce Bulletin*—Vol. 6, No. 8, Feb. 14, 1935, page 187.

T. Shaped Vertical Aircraft Radio Antenna Found to be One of Most Suitable Types of Flying Radio Range Beacon—*Air Commerce Bulletin*—Vol. 6, No. 8, Feb. 15, 1935, page 187.

Antennas for Radio Range Reception—*Air Commerce Bulletin*—Vol. 4, No. 21, May 1, 1933, page 528.

On the Daylight Transmission Characteristics of Horizontally and Vertically Polarized Waves from Airplanes—F. H. Drake and R. M. Wilmotte—*I. R. E. Proceedings*—Dec. 1929, page 2242.

Characteristics of Airplane Antennas—E. Bellini—*Wireless Age*—Vol. 11, November, 1923, page 54.

Sulle Antenna Radiotelegrafiche dei Veicoli Aerei—A. Marino—*L'Elettrotecnica*—Vol. 9, April 15, 1922, page 242.

Wireless "Earths" on Aircraft—H. Dady—*Wireless Age*—Vol. 8, Feb. 1921, page 29.

Energetische Messungen im Hertzsch Felde der Flugzeugantenne—R. Baldus and R. Hase—*Jahrb. D. Drahtl. Telegraphic*—Vol. 15, May 1920, page 354.

Airplane Antenna Reels—L. Ryan—*Electrical Experimenter*—Vol. 7, August 1919, page 324.

Airplane Antenna Constants—J. M. Corck—*Bur. of Stds. Scientific Paper #341*, Sept. 1919—*Jrnl. Franklin Institute*, Vol. 188, 1919, page 446—*Radio Amateur News*—Vol. 1, December 1919, page 292—*Radio Review*—Vol. 1, January 1920, page 185—*Wireless World*—Vol. 8, April 3, 1920, page 15.

New Form of Catenary (Trailing Wire Antenna)—J. Hollingsworth—*Phil. Mag.*—Vol. 38, October 1919, page 452.

[Continued on page 72]



Something to Remember about having your CAPACITOR SPECIFICATIONS MATCHED

SPRAGUE CAPACITOR TYPES

- Dry Electrolytic
- Paper Dielectric
- Mica Dielectric
- Power Factor Correction
- Motor Starting
- High Voltage Networks
- Radio Noise Suppression
- Filters, etc., etc.

In designing or producing a radio or electrical product, there are plenty of things to think of besides capacitors. Moreover, unless you've specialized, it's difficult to keep fully abreast of modern capacitor developments. That's why we make this suggestion:

Write today for a supply of Sprague Sample Request Forms. Then, as capacitor applications arise, use these forms to send full details to Sprague engineers. Let them make suggestions. Benefit from their broad experience, as well as from the fact that Sprague regularly produces dozens of standard

Capacitor types, plus hundreds of adaptations and special units.

Such a request places you under no obligation to buy the recommended type. It simply assures you of specialized attention in the selection of an important component on which there are many factors to consider—angles which cannot always be cataloged completely or promptly, or which cannot be uncovered in any other way than through this personalized engineering service.

Write today for a supply of Capacitor Sample Request Forms.

SPRAGUE ELECTRIC COMPANY, North Adams, Mass.
(Formerly Sprague Specialties Co.)

A typical group of Sprague Dry Electrolytic Capacitors designed to match special specifications.

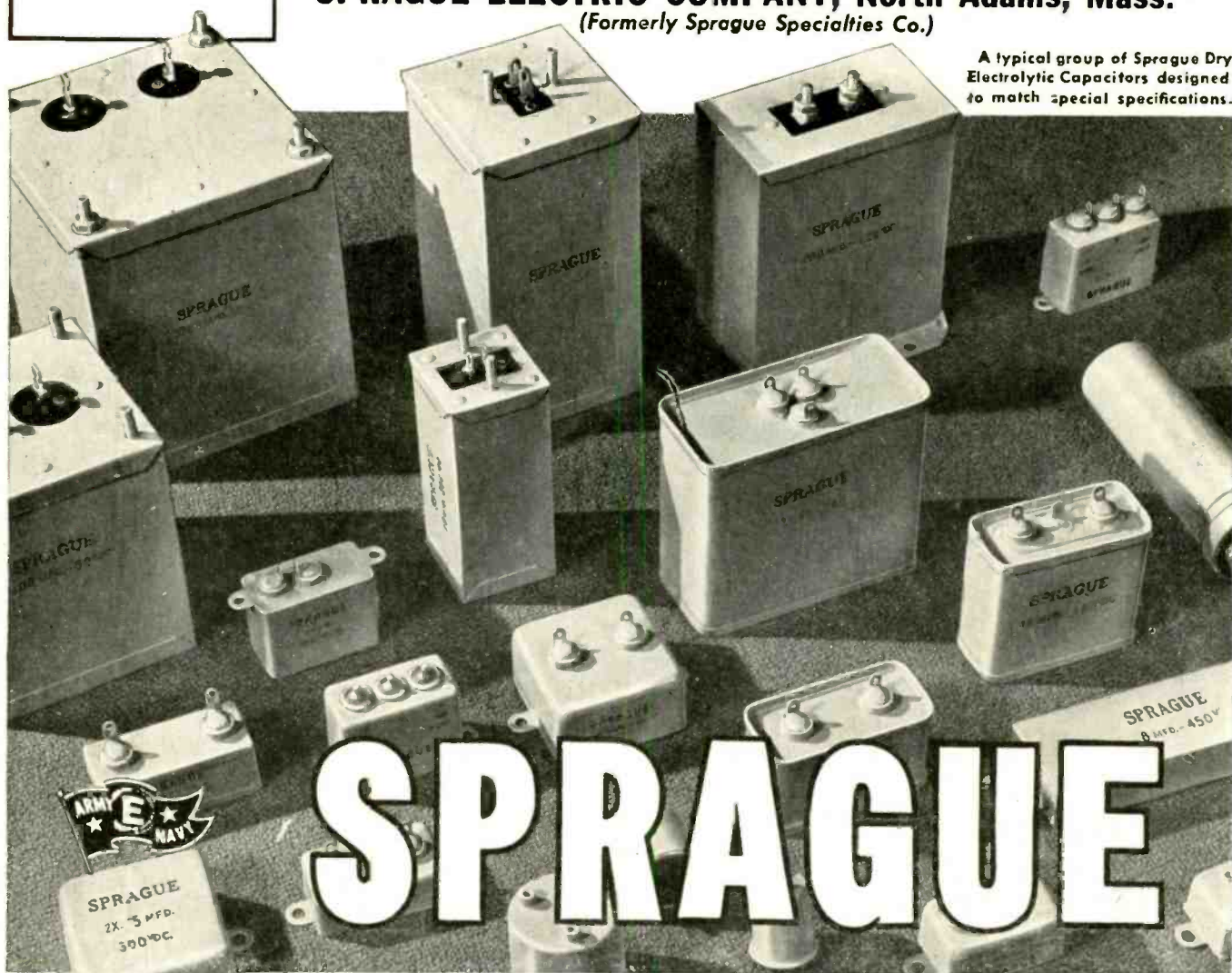

SPRAGUE

CAPACITORS • KOOLOHM RESISTORS

T. M. REG. U. S. PAT. OFF.



MEASURES QUANTITIES

with greater sensitivity & range than ever before accomplished



PATS. APP. FOR

TECH LAB MICROHMMETER

... gives direct and instantaneous readings of resistance values down to 5 microhms and up to 1,000,000 megohms. Accuracy in all measurements to better than 2%. Output is sufficient to drive recorder. Entirely AC operated. Furnished in two models. Reasonably prompt deliveries. For complete data regarding other applications write for Bulletin No. 432.



Quality manufacturers of attenuators and other electrical complete data write for Bulletin No. 431.



13 LINCOLN STREET
JERSEY CITY 7, N. J.

BIBLIOGRAPHY

[Continued from page 70]

On the Form of the Trailing Aerial—H. C. Plummer—*Phil. Mag.*—Vol. 38, December 1919, page 732.

Principles of Radio Transmission and Reception with Antenna and Coil Aerials—J. H. Dellinger—*Bur. of Stds. Scientific Papers #354*, December 1919.

Elastic Vibration of Quartz—G. W. Williard—*Bell Lab. Record*—April, 1936 page 250.

Multi-Frequency Radio Transmitter—J. B. Bishop—*Bell Lab. Record*—July 1936, page 350.

Quartz Oscillator Wave Constants—E. G. Watts — *Radio Engineering* — September 1931, page 23.

Oscillating Characteristics and Temperature Coefficient of Quartz Oscillators—H. Straubel—*Zeit. für Hochfrequenztechnik*—July 1931, page 14.

Accurate Method of Measuring Transmitted Wave Frequencies at 5000 and 20,000 Kilocycles per Second—E. L. Hall—*I.R.E. Proc.*—January 1931, page 35.

Application of Piezoelectric Crystals to Receivers—R. R. Batcher—*Electronics*—August 1931, page 57.

Measurement of Temperature Coefficient and Pressure Coefficient of Quartz Crystal Oscillators—S. L. Brown and S. Harris—*Review of Scientific Instruments*—March 1931, page 180.

A New Oscillator for Broadcast Frequencies—O. M. Hovgaard—*Bell Lab. Record*—Dec. 1931, page 106.

Investigation of Quartz Controlled Oscillation Processes—P. von Handel—*Elektrische Nachrichten-Technik*—Jan. 1930, page 34.

Transversal Oscillating Light Resonators as a Frequency Standard in Range from 1,000 to 20,000 Hertz—E. Giebe and A. Schiebe—*Zeit. für Hochfrequenztechnik*—May 1930, page 166.

Uses of Oscillating Piezoelectric Quartz Plates—R. C. Hitchcock—M. A. Foote Prints—Vol. 3, No. 1, 1930. page 3.

The Dimensions of Low Frequency Quartz Oscillators—R. C. Hitchcock—*Review of Scientific Instruments*—January 1930, page 13.

Design and Manufacture of Oscillating Quartz Plates—S. Matsumura and K. Takahashi—*Electrotech. Lab. Circular*—July 1930.

New Piezo Oscillations with Quartz

Cylinders Cut Along the Optical Axis—A. Hund and R. B. Wright—*U. S. Bureau of Standards Jnl*—March 1930, page 384.

Method and Apparatus used in Testing Piezo Oscillators for Broadcasting Stations—E. L. Hall—*U. S. Bureau of Standards Journal*, January 1930, page 115.

Design of a Portable Temperature Controlled Piezo Oscillator—V. E. Heaton and W. S. Brattain—*U. S. Bureau of Standards Journal*, March 1930, page 345.

The Establishment of the Japanese Radio-Frequency Standard—Y. Namba—*I.R.E. Proc.*—June 1930, page 1017.

Design of a Portable Temperature Controlled Piezo Oscillator—V. E. Heaton and W. H. Brattain—*I.R.E. Proc.*—July 1930, page 1247.

Electroelastic and Pyro-Electric Phenomena—W. G. Cady—*I.R.E. Proc.*—July 1930, page 1247.

Interpolation Methods for Use with Harmonic Frequency Standards—J. K. Clapp—*I.R.E. Proc.*—Sept. 1930, page 1575.

A Precise and Rapid Method of Measuring Frequencies from Five to Two Hundred Cycles per Second—N. P. Case—*I.R.E. Proc.*—September 1930, page 1586.

An International Comparison of Frequency by Means of a Luminous Quartz Resonator—S. Jimbo—*I.R.E. Proc.*—November 1930, page 1930.

Characteristics of Piezo-Electric Quartz Oscillators—Isaac Koga—*I.R.E. Proc.*—November 1930, page 1935.

Temperature Control for Frequency Standards—J. K. Clapp—*I.R.E. Proc.*—December 1930, page 2003.

Summary of Piezoelectric Crystal Conference Held by U. S. Navy Department Dec. 3-4, 1929—*I.R.E. Proc.*—December 1930, page 2128.

Piezoelectric Terminology — Walter G. Cady—*I.R.E. Proc.*—December 1930, page 2136.

Push-Pull Piezoelectric Oscillator Circuits—J. R. Harrison—*I.R.E. Proc.*—January 1930, page 95.

Quartz Control for Frequency Stabilization in Shortwave Receivers—P. Van Handel, K. Kruger and H. Plendl—*I.R.E. Proc.*—February 1930, page 307.

Some Remarks on the Multivibrator—Yasui Watanabe—*I.R.E. Proc.*—February 1930, page 327.

Method and Apparatus Used at the Bureau of Standards in Testing Piezo Oscillators for Broadcast Stations—E. L. Hall—*I.R.E. Proc.* March 1930 page 490.

Adaptability in CERAMICS

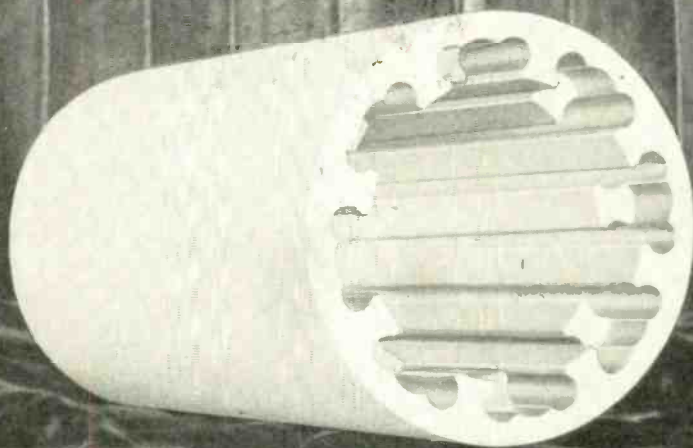

COIL FORM FOR INTERNAL WINDING by **STUPAKOFF**

Permanently strong and stable both mechanically and electrically, ceramics are versatile materials capable of intricate design. Competent engineering enables dimensional tolerances to be held to a minimum.

The internally wound coil form illustrated is engineered and produced by Stupakoff for a specific application. Resistance to thermal shock and mechanical strength are specifications

embodied in this one-piece extruded insulator. Slotted, longitudinal winding holes expose the heating element and allow heat to be directed instantaneously to the center of the coil.

Specialists in the field of electrical insulation, Stupakoff engineers are trained to find *specific* solutions for *your* insulation problems. Contact Stupakoff today —two generations of dependability in the ceramic field justify this choice.



STUPAKOFF CERAMIC AND MANUFACTURING CO., LATROBE, PA.

Ceramics for the World of Electronics

**NOT NEXT WEEK
NOT NEXT MONTH
NOT NEXT YEAR
BUT-NOW**



HARVEY
has for fast delivery
Critical Radio and
Electronic Components
and Equipment

TUBES	METERS
RELAYS	TEST EQUIPMENT
CAPACITORS	TRANSFORMERS
RESISTORS	ETC., ETC.

After 18 years in the radio and electronic field, HARVEY is adept at supplying you with equipment you need—not next week, not next month, not next year—but now, just when you need it. That's the service for which we are famous. Critical items, if not on our shelves, will be traced for you, or we may be able to suggest effective substitutes. And HARVEY can help solve your priority problems, lend a hand with technical advice. Save time, save money... see HARVEY—first, last, always!

Telephone
Orders to
LONGACRE 3-1800



HARVEY
RADIO COMPANY
103 WEST 43rd ST., NEW YORK 18, N. Y.

RELAYS

[Continued from page 48]

tilted slightly from the plane of the armature to accentuate the wiping action between contacts as they are opened and closed. From the above, it can be seen that this relay can be used for three types of duty—Medium power, High-voltage and r-f control.

Specifications—

Coil—Operating voltage up to 115 V.D.C. Wattage demand—3 watts.

Contact Arrangement—D.P.D.T. Rating—10 amp. at 110 V.A.C. non-inductive. 10 amp at 24 V.D.C. non-inductive. 1 amp at 1000 V. at 20 megacycles. Contacts cannot safely open on 1000 V.D.C.

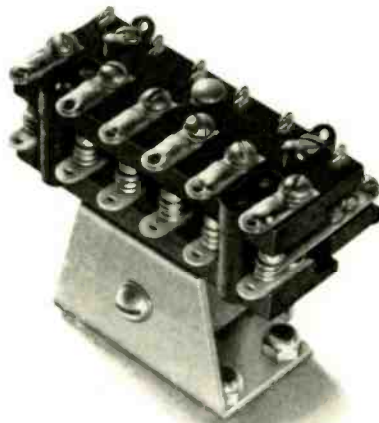

Fig. 19. Low-power relay
(Courtesy Allied Control Co.)

Low-Power Relay

Frequently there is need for a small low-power relay to handle loads of about 5 amperes. The relay illustrated in Figs. 19 and 20 is designed to control power loads of this level. Terminal spacing has been trimmed to the minimum consistent with what is regarded as safe for power circuits. In general, communications circuits will be found to have less creepage over insulation than power circuits for the same voltages. This is not the result of any planned calculations, but rather is founded on experience which indicates a breakdown on a power circuit is more destructive. The stud mounting saves on chassis

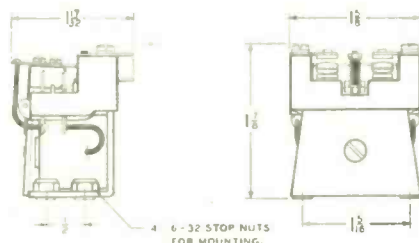

Fig. 22. Diagram of medium-power relay
(Courtesy Allied Control Co.)

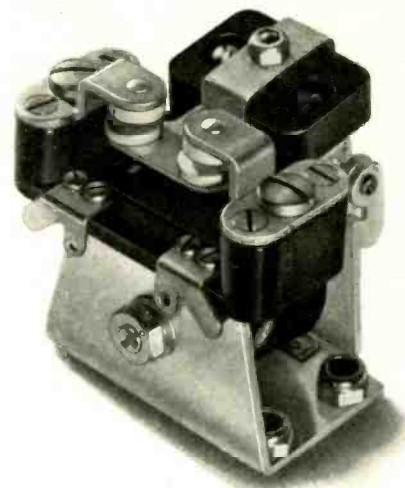

Fig. 21. Medium-power relay
(Courtesy Allied Control Co.)

space. Flange mountings are frequently necessary for accessibility but are wasteful of space.

Specifications—

Coil—Operating voltage up to 84 V.D.C. Wattage demand—2 watts.

Contact Arrangement—D.P.D.T. or less. Rating—5 amp at 24 V.D.C. (non-inductive). 5 amp at 110 V.A.C. (non-inductive).

Medium-Power Relay

For the control of power to a piece of apparatus, the relay shown in Figs. 21 and 22 will usually prove to be the best choice. The contacts will handle 15 amperes and potentials up to 460 V.A.C. Contact arrangements from S.P.S.T.—double break to 4 P.D.T. can be had.

Contrasted with the relays discussed previously, it will be noticed that these power relays carry the armature contact spring on an insulator attached to the armature. Connection from the moving contact spring to the terminal is made by an insulated flexible pigtail-lead covered with a piece of flexible sleeving. As contacts and contact-springs become heavier, the flexing of the contact springs begins to require too much power from the magnetic coil. It is still necessary to have some spring action on each contact to take up the misalignment between contacts and assure enough pressure on each contact. By mounting contacts on short contact springs and using flexible leads, these objectives are met.

Where considerable current is carried, sticking (welding) of contacts due to dirt on the surfaces or contact-bounce is much more likely. To reduce this possibility a large amount of wipe is desirable. This is accomplished by mounting the plane of the contacts at right angles to the plane of the armature and slightly above the hinge. Then,

[Continued on page 76]

MEMO

Tell Joe to be sure
to specify RACON
Speakers for that
big P.A. job to
assure our getting
the contract.
Everybody knows
RACON'S are "tops".

SEND FOR OUR CATALOG

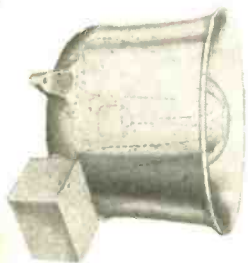

MARINE HORN SPEAKERS, approved by the U. S. Coast Guard, may be used as both speaker and microphone. Available in several sizes.

RE-ENTRANT TRUMPETS, compact, of the double re-entrant type, afford long air-column in small space; deliver highly concentrated sound over long distances.

P.M. HORN UNITS are available in operating capacities of 5 to 50 watts.

It is common knowledge that well-planned Public Address installations and sound distribution systems effectively accomplish their purpose, such as speeding up production, eliminating time wastage in communicating orders and instructions, etc. That's why such P-A installations are being authorized, in fact, are being urged upon factories in war work.

The vital components of any sound installation are the loudspeakers and driving units. These must be absolutely dependable and efficient, rugged, afford long, troublefree service. And they must deliver more watts of energy output per watt of input for economy's sake. That RACON speakers do all these things best and at lower cost is a recognized fact too. That's why soundmen who specify RACONS have a edge on competitors. They usually get the contract.

RACON ELECTRIC CO. 52 EAST 19th ST. NEW YORK, N. Y.

FLEXIBILITY

IN SURCO-AMERICAN PLASTIC TUBING

The great variety of present applications speaks volumes for the flexibility of Surco-American Plastic Insulating Tubing. Even under extreme conditions of heat, cold, moisture, wear, changes in weather, and in the presence of dilute acids, oils and most solvents, the same degree of flexibility prevails.

Surco-American offers a wide range of standard and special



formulations, clear or in any color, with such specifications as high insulating resistance, low power factor, or an average dielectric strength of 1500 volts per mil thickness. Every formulation is laboratory tested. Available in continuous lengths, I. D. —.005 to 2". Also flexible plastic insulated wire, #12 to #48 A. W. C., insulating tape and special tubing and wire. Complete technical data furnished.

Surprenant
ELECTRICAL INSULATION CO.
Dept. J
84 Purchase St., Boston 10, Mass.

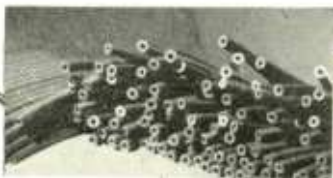

By exclusive winding and packaging, Surco-American Tubing stays round on the spool.

RELAYS

[Continued from page 74]

as the contacts open and close, there will be a large component of motion across the face of the contacts.

To make a double-break contact arrangement, two armature springs are used as for a double-pole arrangement. The flexible leads are omitted and the armature springs connected together by a jumper.

For operation on A. C., the core of the coil is made of laminated silicon-steel in the same fashion as a-c telephone-type Relays.

Specifications—

Coil—Operating voltage up to 115 V.D.C. Wattage demand on D. C.—2.5 watts. Operating voltage up to 250 V.A.C., 60 cycle. Power demand on A. C.—4.5 V.A.

Contact Arrangement—D.P.D.T. or less, 1½ wide as shown. 3P.D.T, 1¾ wide. 4P.D.T., 2 3/16 wide.

Rating—15 amp. at 32 V.D.C., non-inductive. 15 amp. at 115 V.A.C., non-inductive. 7.5 amp. at 230 V.A.C., non-inductive. 2.5 amp. at 460 V.A.C., non-inductive.

FILAMENTS

[Continued from page 43]

SUMMARY:

The advantages of single-phase over three- or six-phase operation of high-power tube filaments may be summarized as follows:

1. Single-phase operation results in longer life expectancy because of the elimination of the magnetic and mechanical forces resulting from phase unbalance.
2. The effective audible level of hum modulation is actually lower for single-phase operation.
3. The cost of the additional protective measures necessary with multiphase operation will more than compensate for the increased cost of filament transformers for single-phase operation.
4. There is less danger of improper filament connection for single-phase operation than for multiphase.
5. By proper attention to dividing the various parts of the total transmitter power load among the power supply phases, any effect of unbalance due to filament supply can be eliminated.

RADIO CLUB OF AMERICA ANNOUNCES 1945 OFFICERS

At the meeting of its directors on January 18, The Radio Club of America, Inc., oldest radio organization in continuous existence, announced the reelection for the 1945 term of the same officers who served the previous year, as follows: President, F. A. Klingenschmitt; Vice-President, O. James Morelock; Treasurer, Joseph Stantley; Corresponding Secretary, M. B. Sleeper; Recording Secretary, John H. Bose; Publicity Chairman, Austin C. Les-carboursa. Mr. Morelock is also Chairman of the Papers Committee and has already lined up several excellent papers for the coming year.

TWO BOOKS EVERY ENGINEER NEEDS

THE CATHODE RAY TUBE AT WORK

By John F. Rider



To use the Cathode-Ray Tube to its fullest capabilities, it is necessary to understand its theory and functioning. This book explains the various types and what role each element plays.

More than half the book is devoted to the practical applications illustrated with oscillograms.

450 ILLUSTRATIONS.
338 PAGES. \$4.00



A-C CALCULATION CHARTS

Faster than a slide rule. It covers all A-C calculations in series circuits, parallel circuits, series-parallel and mesh circuits, at frequencies from 10 cycles to 100 megacycles.

146 Charts—7" x 11"
Two colors \$7.50.

JOHN F. RIDER Publisher, Inc.

404 FOURTH AVENUE, NEW YORK 16, N. Y.
EXPORT DIV.: ROCKE INTERNATIONAL ELEC. CORP.
13 E. 40TH STREET, NEW YORK CITY. CABLE ARLAB

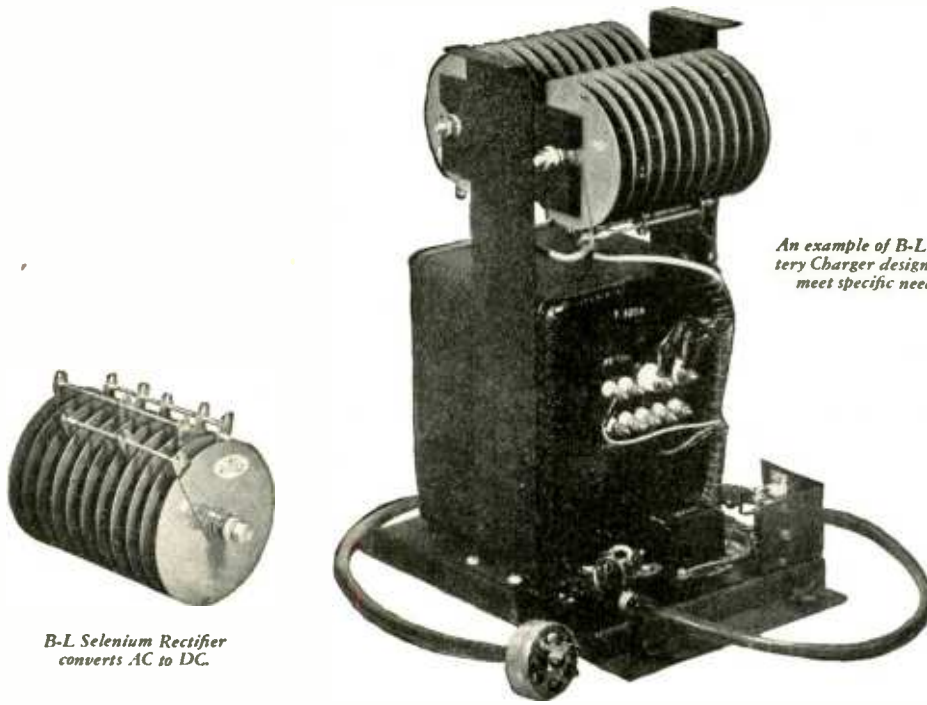

An example of B-L Battery Charger designed to meet specific needs.



B-L Selenium Rectifier converts AC to DC.



Specially designed B-L Transformer delivers 12 volts from the 115 volt output of the power supply.

This B-L Battery Charger meets special requirements of the Signal Corps

The problem of designing and manufacturing a charger for Signal Corps equipment which would meet the needs of increased loads was submitted to B-L engineers. The result is a Battery Charger producing *three times* the rate originally employed. It charges the batteries, and *keeps them charged*, in the Signal Corps equipment shown at the right.

The alternating current power supply is converted to direct current by sturdy, specially built B-L Selenium Rectifiers which meet the demands of this unit for charging the 6-cell 12-volt batteries. . . . The Charger itself is built to withstand rough usage and the severe moisture of the tropics.

A switch controls rate of delivery—5 amperes or 15 amperes . . . The built-in Thermal Circuit Breaker protects against overloads—the push button resets . . . The cut-out relay provides against any discharge of batteries in the event of power failure . . . Four fasteners permit handy removal from or installation to the base.



Mobile Unit, with Trailer, made for the U. S. Signal Corps by The Hallicrafters Co., Chicago.

Have You a Conversion Problem?

Twenty-five years of B-L specialized skill in AC-DC conversion problems is available to you. We are designers of Selenium and Copper Sulphide Rectifiers, Battery Chargers, and DC Power Supplies for practically every requirement. We invite your inquiries—without obligation.

SELENIUM



COPPER
SULPHIDE

THE BENWOOD LINZE COMPANY

1815 Locust Street • • • St. Louis 3, Mo.

DESIGNERS AND MANUFACTURERS OF COPPER SULPHIDE AND SELENIUM RECTIFIERS, BATTERY CHARGERS, AND D. C. POWER SUPPLIES FOR PRACTICALLY EVERY REQUIREMENT.



SM Fractional H.P. Motors for blower, band switching, turntable, and other radio applications.

You can get a SM motor engineered and precision-built to your exact job specifications to give you maximum power per ounce of weight and per inch of space, long life and dependable performance. From 1/10th to 1/200th H.P. Speeds from 3,000 to 20,000 R.P.M. Voltage from 6 to 220 AC-DC. SM motors are built of quality materials in a plant with facilities for large volume production. Many thousands have been designed and built for signal corps and military aircraft use. What are your requirements?



Dept. 30—1308 ELSTON AVE., CHICAGO 22, ILL.

Manufacturers of special small universal, fractional H. P. motors, dynamotors, shaded pole motors, heater motors, generators.

Design • Engineering • Production

NEW PRODUCTS

(Continued from page 72)

to 110 micromicrofarads in steps of one micromicrofarad, accurate within one mmfd. plus or minus. A special grade of I.C.E. Vacuum Capacitors is also available offering tolerances held to tenths of one mmfd. Thus it is now possible to secure vacuum capacitors with capacitance values other than the conventional models.

ELECTRICAL CONNECTING DEVICES

A new 32 page catalog, No. 14, has just been released by Howard B. Jones Company of Chicago. It illustrates and describes their complete line of multi-contact Plugs and Sockets, Terminal Strips, Fuse Mounts, etc.

A request to this publication or direct to Howard B. Jones Co., 2460 W. George Street, Chicago 18, will bring a copy to you promptly.

NORELCO CATALOG

A new 8-page condensed catalogue called "Norelco Electronic Products" has been announced by North American Philips Company, Inc., 100 East 42nd Street, New York.

The subjects covered are as follows:

1. Cathode-ray, transmitting, power and amplifier tubes.
2. Quartz crystal oscillator plates.
3. Searchray (X-ray) inspection units.
4. Geiger-counter X-ray Spectrometer.
5. Film-type X-ray diffraction equipment.
6. Metallurgical products—tungsten and molybdenum powder, rod, sheet and wire. Also aluminum alloy, enameled copper, resistance, silver and gold-clad silver wire in fine sizes.
8. Medical X-ray equipment—radiographic units, tables, tube stands and miscellaneous accessories.

MIDGET TRANSFORMER

A new transformer, 31/32" x 37/64" x 7/16", small enough to be incorporated directly into the cases of earphones and hand-held microphones, has been developed by Permoflux Corporation to meet the

needs of efficient light weight communication and electronic equipment.

A new design, combined with newly developed materials and manufacturing methods, results in an 80% to 90% operating efficiency with a uniform frequency response of ± 2 d.b. from 100 to 8,000 cycles. These transformers can be made

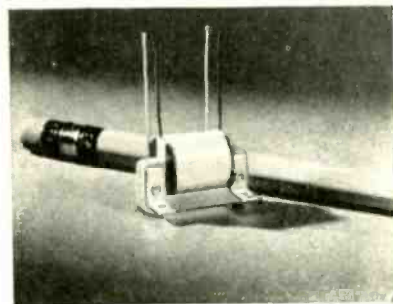

with windings to provide impedances as high as 200,000 ohms and, when used as a choke coil, with inductive reactance as high as one megohm. They may be potted, shielded or hermetically sealed if desired.

Permoflux Corporation, 4900 West Grand Avenue, Chicago 39, Illinois, designers and manufacturers of these new transformers, welcome inquiries regarding their many applications.

RUBBER CEMENT

A new rubber cement, named Plastilock 500, a non-thermoplastic, water and aromatic oil-resistant adhesive for bonding metals, wood, plastics and ceramic material to themselves or to each other is announced by The B. F. Goodrich Company, Akron, Ohio. The company claims it provides superior bonding qualities in any of its applications, and in some cases can be used in place of rivets or screws.

The new adhesive, used for metal-to-metal bonding, has shown a shear strength of 3,250 pounds per square inch. Tension strengths of 4,000 pounds per square inch have been reached. Tests made after the bonding of wood and plastic to aluminum, which presents extremely difficult problems of adhesion to other materials have resulted in the wood and plastic being torn because the strength of the bond was greater than that of these materials.

SYNONYMOUS THOUGHTS: THORDARSON *and* TRANSFORMERS

TO SUPPLY
EVERY KNOWN
NEED!



THORDARSON

TRANSFORMER DIVISION
THORDARSON ELECTRIC MFG. CO.
500 WEST HURON STREET, CHICAGO, ILL.

Transformer Specialists Since 1895
ORIGINATORS OF TRU-FIDELITY AMPLIFIERS

RADIO

**GROUP SUBSCRIBERS
SAVE UP TO 50%***

and Here's Why:



LOOK WHAT I SAVE--
A \$3 SUBSCRIPTION
FOR ONLY HALF!!!



MEBBE THEY'LL LEAVE
MY RADIO MAG FOR
ME FROM NOW ON



I NEVER GOT AROUND
TO SUBSCRIBING--THIS
IS QUICK AND EASY

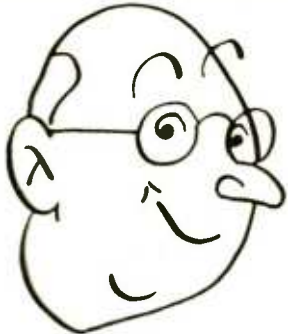

ME--I'M BUILDING A
REFERENCE LIBRARY
OUT OF EACH ISSUE

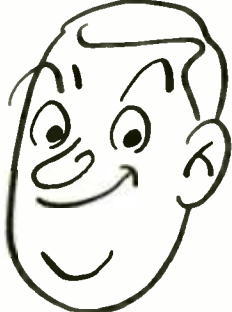

I'LL BE ABLE TO FOLLOW
PRESENT AND POST-WAR
DEVELOPMENTS



IF THEY'RE ALL GETTING
IT--I WANT TO KNOW
WHAT THEY'LL KNOW

FORM YOUR GROUP TODAY--

Every month, vital departments acquaint you with newest developments — editorial "ear-to-the-ground" releases keep you abreast of trends, in fact, ahead of most coming events.

For a limited time only—save up to half the regular cost of a RADIO subscription by using the Group Plan. The more in a Group the more each saves, up to 50%.*

*** THE GROUP PLAN**

Here's what Group Subscriptions cost:

One 1 yr. subscription	\$3.00
Two 1 yr. subscriptions	2.50 each
Three 1 yr. subscriptions	2.00 "
Four 1 yr. subscriptions	1.75 "
Five 1 yr. subscriptions	1.60 "
Six or more 1 yr. subscriptions	1.50 "

Make a list giving each subscriber's name, address, employer's name and their respective positions.

RADIO MAGAZINES, INC.

342 MADISON AVENUE

NEW YORK 17, N. Y.

NATION-WIDE
MAIL ORDER
DISTRIBUTORS
SINCE 1928



**RADIO AND
ELECTRONIC
DEVICES**

For...

TRADE
INDUSTRY
VOCATIONAL
COMMUNICATION
PUBLIC UTILITY
and
EXPERIMENTAL
APPLICATIONS

BURSTEIN-APPLEBEE CO.
1012-14 MCGEE ST.
KANSAS CITY 6, MISSOURI

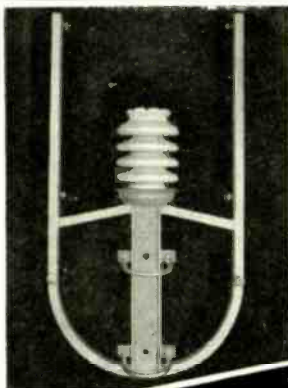

**TRANSMISSION
LINE SUPPORT**

Interested in an open wire line?
The support illustrated above is one of several types Johnson can furnish. It mounts on a 3 inch iron pipe or a 4x4 inch wood pole and comes complete with center insulator and hardware.
Suitable for 5, 6 or 7 wire, balanced lines, for antenna power up to 50 KW, the support is approximately 17x31½ inches overall and the outside conductors form a 15 inch square.

Write for information and catalog 968(K)



JOHNSON
a famous name in Radio

E. F. Johnson Co. Waseca, Minn.

NEW PRODUCTS

(Continued from page 78)

Directions for applying Plastilock 500, as given by the company, are:

Remove dirt, grease and scale from both surfaces to be bonded. Apply three coats of Plastilock 500 to each surface and dry each coat at room temperature for at least one hour. If thinner is required, use denatured alcohol. Then assemble and pre-heat at 250 degrees Fahrenheit for 30 minutes, 300 degrees Fahrenheit for 20 minutes or 350 degrees Fahrenheit for 10 minutes. Follow this by applying sufficient pressure to get good surface contact without squeezing out the adhesive and heat at 250 degrees Fahrenheit for 45 minutes, 300 degrees Fahrenheit for 25 minutes or 350 degrees Fahrenheit for 12 minutes.

BLOWER

A new light weight blower for heat dispersion, the Model No. 2½, has been added to the line of the L. R. Manufacturing Company, Division of The Ripley Company, Torrington, Connecticut. The one piece housing with aluminum motor



plate is 4½" from top to bottom. Operating under all conditions of climate and temperature the unit which weighs but 3½ ounces delivers 50 C.F.M. at 8000 R.P.M. It is available with shaft bores of either .1895 inch or ¼ inch.

With the addition of this new model to its line the L. R. Company now has available blowers ranging in size from 3" to 6½" with weights from 2 ounces to 12 ounces and with capacities ranging from 15 C.F.M. to 270 C.F.M. at 8000 R.P.M.

- Need an Electronic Product Designed NOW?
- Need the Professional Assistance of Electronic Consultants in YOUR Design?

Let our experienced staff take over the complete design responsibility of a communication or electronic product for you to manufacture, or if you require expert assistance in your design, call on us as your consultants. Write today, describing your problem.

ELECTRONIC ENGINEERS
Designers & Consultants

Box 272 Radio Mag.

**Wanted
ENGINEERS**

Radio

- * Electrical
- Electronic
- * Mechanical
- * Factory Planning
- Materials Handling
- Manufacturing Planning

Work in connection with the manufacture of a wide variety of new and advanced types of communications equipment and special electronic products.

Apply (or write), giving full qualifications, to:

R.L.D., EMPLOYMENT DEPT.,

Western Electric Co.

100 CENTRAL AV., KEARNY, N. J.

*Also: C. A. L.

Locust St.,

Haverhill, Mass.

Applicants must comply with WMC regulations

**WANTED
DESIGNER**

A Central New England manufacturer employing over 1000 people needs Draftsman-Designer on telephone and signaling (mechanical) apparatus.

Knowledge of die-casting and plastic applications desirable.

WMC Regulations Prevail.

Reply to Box 223,
c/o RADIO Magazine

**WANTED
DEVELOPMENT ENGINEERS**

Mechanical and electrical. Graduate or equivalent training. Required for development work in the following branches:

1. Electro-mechanical devices, communication systems. Must be interested in development and familiar with magnetic circuits.
2. Measuring and control instruments. Background should be in electrical engineering, including electronics. Statement of Availability Required.

Box 222, c/o RADIO Magazine

• Ted McElroy

World's Largest Manufacturer of
Wireless Telegraphic Apparatus

COMPLETE CENTRAL OFFICE EQUIPMENT

McElroy Manufacturing Corp.

82 Brookline Avenue • Boston, Massachusetts

"Oh, she's OLD!
Almost thirty!"



At twenty, thirty seems ancient.

At thirty, forty is distant middle age.

At forty, well, it'll be a long time before you're fifty.

The point is that ten years *ahead* always seems like a long time. Yet, actually it passes "before you know it" . . . and you find yourself face to face with problems, opportunities, needs, that once seemed very far in the future.

This is a good thing to remember today, when you buy War Bonds to speed the winning of the war.

In ten years—*only* ten years—those bonds will bring you back \$4 for every \$3 you put into them today.

Think of what that money may mean to you in 1955. An education for your children . . . a home . . . maybe even retirement to the place and the life of your heart's desire.

All this your War Bonds can mean to you . . . if you buy all you can today and hold them to maturity.

It won't be long till 1955. Not half as long as you think.

RADIO

This is an official U.S. Treasury advertisement—prepared under auspices of Treasury Department and War Advertising Council

RADIO

★ MARCH, 1945

81

VACUUM TUBE VOLTMETER RF - AC - DC

The result of 10 years of
Vacuum Tube Voltmeter
Engineering.

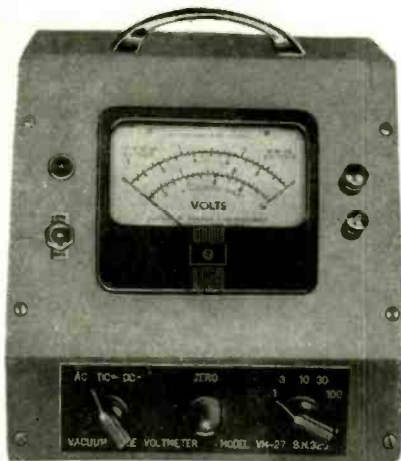

MODEL VM-27

1-3-10-30-100 volts full scale.
Peak response, r.m.s. calibration.
HIGH IMPEDANCE—4 megohms at 50
cycles, 60,000 ohms at 100 megacycles.
7 megohms for d.c.
ACCURATE—Better than 2 percent on
d-c and 60 cycles thru megacycles.
SELF-CONTAINED—115 or 230 volt
50-60 cycle line operation.



RF PROBE

Interchangeable probe included for
convenience and efficiency in making
AC and RF measurements. Input ca-
pacity 5 micro farads. Ruggedly
mounted 6H6 tube in balanced circuit.
Complete \$150 net f.o.b. Flushing, N. Y.

ACCESSORIES

To increase VM-27 range to 1000 volts.



10X AC MULTIPLIER MODEL ACM-27

Input impedance even greater than
probe alone. Flat response from 20
cycles to 200 megacycles.

\$17.00 net f.o.b. Flushing, N. Y.



10X DC MULTIPLIER MODEL DCM-27

5 megohms input resistance.

\$8.00 net f.o.b. Flushing, N. Y.

IMMEDIATE DELIVERIES

ALFRED W. BARBER LABORATORIES
34-04 FRANCIS LEWIS BLVD.
FLUSHING, N. Y.

ADVERTISING INDEX

ADVERTISER	PRODUCT	PAGE
Acme Elec. & Mfg. Co.	Transformers	23
Aerovox Corporation	Capacitors	70
Albion Coil Company	Coils	19
Alden Products Company	Radio Components	67
Allied Radio Corporation	Electronic Equipment	12
Altec-Lansing Corporation	Loudspeakers	14
American Microphone Co.	Microphones	65
American Phenolic Corporation	Plugs, Cables, Connectors, Sockets	6
Amperite Co.	Relays	18
Arnold Engineering Co.	Engineering Equipment	11
Automatic Elec. Sales Corp.	Relays	21
Barber Labs., Alfred W.	Test Equipment	82
Bell Telephone Labs.	Institutional	22
Benwood Linze Company, The	Communications Equipment	77
Biley Electric Co.	Quartz Crystals	8B
Bridgeport Mfg. Company	Coils	83
Burstein-Applebee Co.	Electronic Equipment	80
Cinadagraph Speakers, Inc.	Speakers	26
Concord Radio Corporation	Electronic Equipment	68
Conn. Tel. & Elec. Div.	Electronic Equipment	15
Drake Mfg. Co.	Neon Light Assemblies	18
D-X Crystal Co.	Crystals & Loop Antennas	23
Eitel-McCullough, Inc.	Tubes & Vacuum Pumps	61
Electronic Engineers	Electronic Equipment	80
Electronic Laboratories, Inc.	Vibrator Power Supplies	8A
Electronic Mechanics, Inc.	Insulating Materials	1
Electro-Voice Corporation	Microphones	16
Federal Tel. & Radio Corp.	Cable, Wire	7, 27
Finch Telecommunications, Inc.	Communications Equipment	4
Formica Insulation Co., The	Laminated Plastics	29
Goodrich Co., The B. F.	Insulation Material	84
Hallcrafters Co., The	Communications Equipment	20
Harvey Radio Co.	Radio & Electronic Equip	74
Harvey Radio Labs., The	Electronic Instruments	Cover 3
Hytron Corporation	Tubes	25
International Resistance Co.	Resistors	17
Jefferson Electric Co.	Transformers	28
Jensen Radio Mfg. Co.	Acoustic Equipment	69
Johnson Co., E. F.	Transmitter Components	9, 64, 80
McElroy Mfg. Co.	Wireless Tel. Apparatus	80
Mycalex Corp. of America	Insulating Materials	30
National Union Radio Corp.	Electronic Tubes	Cover 4
Racon Electric Co.	Speakers	75
Radex Corporation	Small Motors	78
Radio Corp. of America	Audio Chanalyst	24
Raytheon Production Corp.	Tubes	Cover 2
Rider, John F. Publ. Inc.	Technical Books	76
Robinson Aviation, Inc.	Airborne Radio & Elec. Equip.	2
Sigma Instruments, Inc.	Relays	66
Sperry Gyroscope Co., Inc.	Radio-Electronic Devices	13
Sprague Electric Co.	Resistors	71
Stupakoff Ceramic & Mfg. Co.	Ceramics	73
Sylvania Electric Products Co.	Tubes	8
Surprenant Elec'l Insulation Co.	Plastic Insulations	76
Tech Laboratories	Attenuators	72
Thordarson Elec. Mfg. Co.	Transformers	78
Triplett Elec. Instru. Co.	Portable Instruments	26
Universal Microphone Co.	Microphones	63
U. S. Treasury Dept.	War Bonds	81
Western Electric Co.	Help Wanted	80
Wrigley Jr., Co., Wm.	Institutional	62

"Have You Heard About the Big War Job They're Doing at Bridgeport?"

"You Bet I Have! And They'll Be Able To Do Just As Good A Job For Us After the War... I've Already Placed our Coil Business With Bridgeport."

**YES,
BRIDGEPORT
WILL DO
A BIG
POSTWAR
JOB**



Right now, Bridgeport is turning out search coils and variometers in the huge quantities necessary to meet the needs of the armed forces, and with the quality required by exacting military specifications. That same capacity and skill will be brought to bear on your postwar orders.



Bridgeport's central location, right near the population center of America, gives you the added advantage of fast, truck line delivery service to any point. Write to us TODAY to insure early postwar delivery of R.F. Coils and Chokes, I.F. Transformers and Transmitting Coils and Chokes.

BRIDGEPORT

MANUFACTURING COMPANY
Bridgeport, Illinois

R. F. Coils • R. F. Chokes • I. F. Transformers
Transmitting Coils • Transmitting Chokes

Another important underground movement

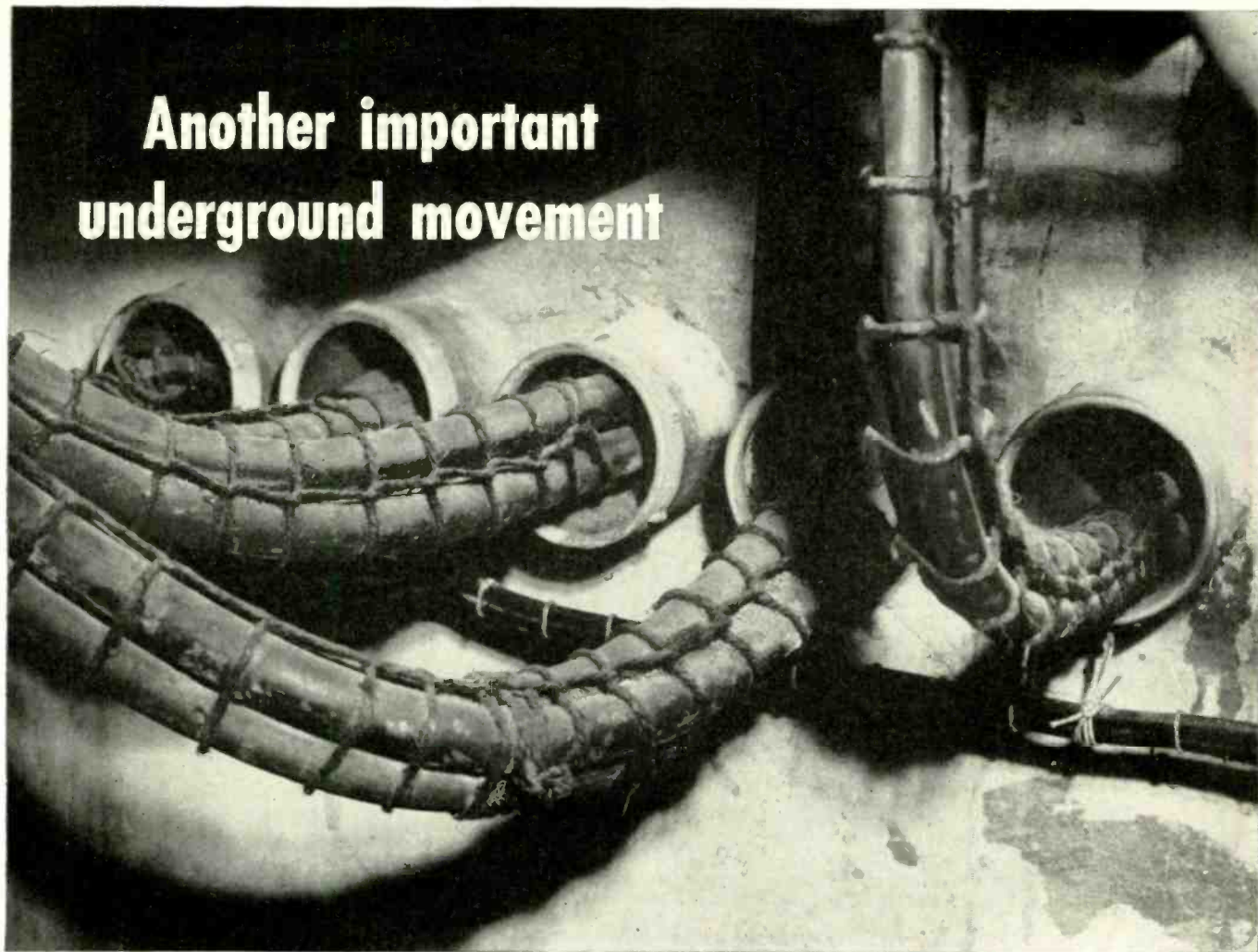

Unsheathed buried power cable insulated with **Geon**

THOSE large power cables represent an important development in the electrical industry. As they pass through the basement wall, they go directly into the earth. There the thinner-than-usual coating of GEON insulation will, without benefit of lead sheathing, resist the effects of the soil's acids and alkalis, will keep out moisture—*while its excellent electrical properties will be maintained.*

On the other extreme, GEON polyvinyl materials have been made into thousands of miles of fine "spaghetti" to slip on radio and switchboard wire. Through the entire range of wire and cable insulation GEON'S unusual properties have made possible a wide variety of applications. In addition to possessing fine electrical properties, GEON resists oils, acids, water, flame, heat, cold. It's practically wearproof. It's smooth—permits

easy handling and installation. Thinner coatings of insulation mean more conductors per conduit. GEON can be brilliantly colored in the entire NEMA range for easy, positive identification.

Urgently needed for military uses, all the GEONS are subject to allocation by the War Production Board. Limited quantities are available for experiment, and our development staff and laboratory facilities will help you work out special problems or applications. For more complete information write Department WW-3, Chemical Division, The B. F. Goodrich Company, 324 Rose Building, Cleveland 15, Ohio.

CHEMICAL DIVISION
The B. F. Goodrich Company

ROSE BUILDING • CLEVELAND 15, OHIO



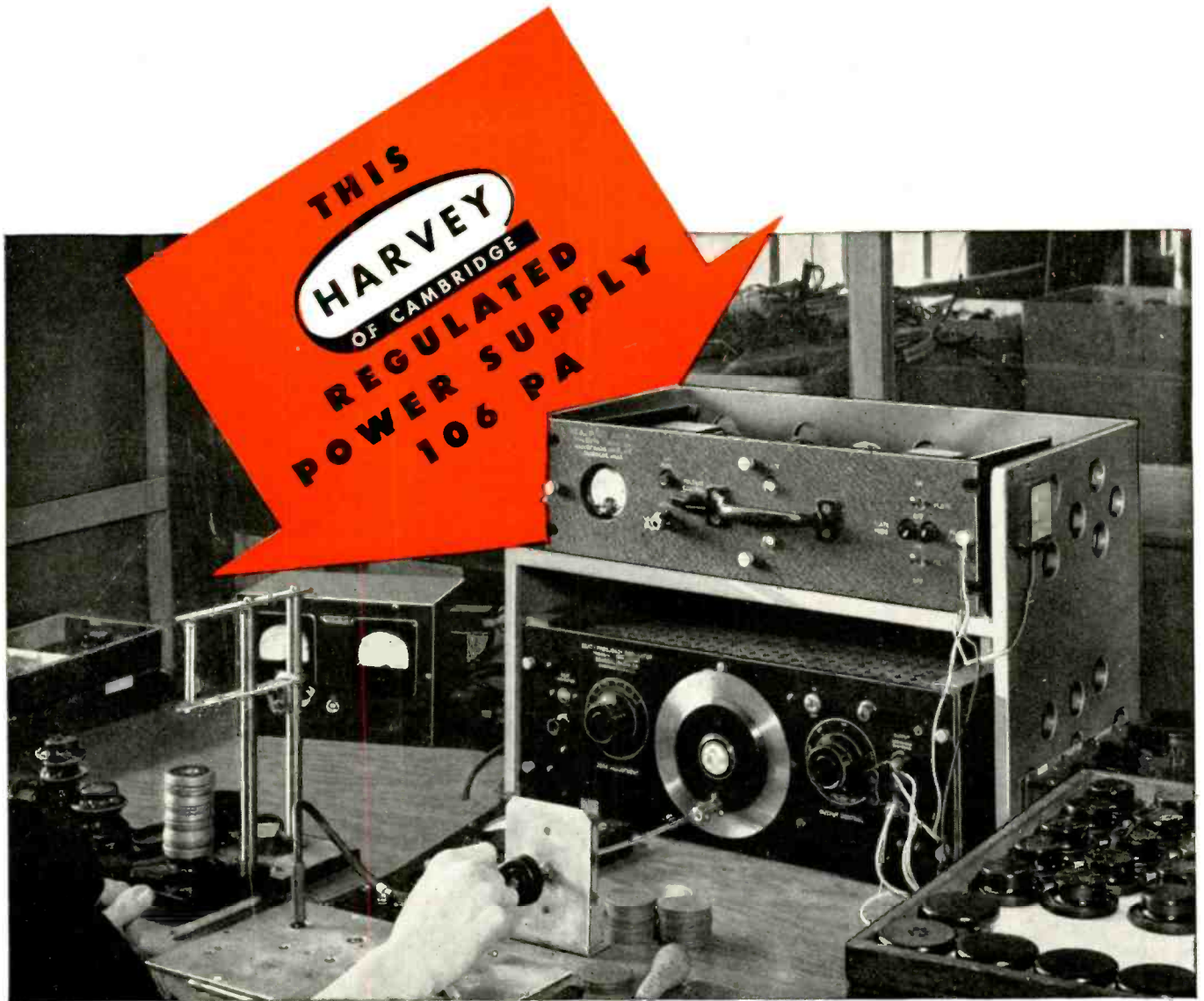

Helps Check The Quality of MURDOCK-Made Head Sets

The *W. J. Murdock Company* of Chelsea, Massachusetts, relies on a HARVEY Regulated Power Supply 106 PA to determine that head sets manufactured by them for the Armed Services meet Signal Corps and Navy Department Specifications.

The HARVEY 106 PA, teamed with a wide range beat frequency oscillator, supplies a constant D.C. voltage for an amplifier testing the output of Murdock type R14 head sets. Input is three volts. Earphones are tested at four frequencies within the range of 500 to 2500 kc., to check various decibel readings within that range.

The HARVEY Regulated Power Supply 106 PA is operating successfully with constant frequency oscillators, amplifiers, pulse generators, measurement equipment and other apparatus requiring a constant source of D.C. current. It operates on 115 volts, 50-60 cycles A.C., and has a D.C. output variable from between 200 to 300 volts that is regulated to within one per cent.

If you need a constant, thoroughly dependable source of D.C. power, better look into the HARVEY Regulated Power Supply 106 PA. The whole story is contained in a new bulletin. We'd be pleased to send it.



HARVEY RADIO LABORATORIES, INC.

454 CONCORD AVENUE • CAMBRIDGE 38, MASSACHUSETTS

ELECTRONIC ENGINEER'S REFERENCE MANUAL

CHARACTERISTICS
BASING DIAGRAMS
Receiver Tubes
Transmitter Tubes
Cathode Ray Tubes
SUBSTITUTION CHARTS
Tubes
Condensers
PHOTOTUBE DATA
TRANSFORMER DATA
CONDENSER DATA
RESISTOR DATA
COLOR CODES
FORMULAE
American War Standards

PRICE \$1.00

Compiled and Published by
COMMERCIAL ENGINEERING DEPARTMENT
NATIONAL UNION RADIO CORPORATION
NEWARK 2, NEW JERSEY

**JUST OFF
THE
PRESS!**

The new ELECTRONIC ENGINEER'S REFERENCE MANUAL now makes available to the practical engineer all the essential up-to-the-minute facts about electron tubes and related parts. More than 900 types of Receiving, Transmitting, Cathode-Ray and Photo Tubes are described—with physical specifications, characteristics, typical operat-

ing conditions, basing diagrams, war-time substitution chart and other data. All this and more in one handy quick-reference book of 146 pages that you can tuck in your pocket. Note ring binding which makes the pages lie flat when book is open. Price \$1.00. For copies write National Union Radio Corporation, Newark 2, New Jersey.